

HarmonicDrive®

CSG-GH High Torque Series

Size

14, 20, 32, 45, 65

5
Sizes

Peak torque

23Nm to 3419Nm

Reduction ratio

50:1 to 160:1

Zero backlash

High Accuracy

Repeatability ± 4 to ± 10 arc-sec

High Load Capacity Output Bearing

A Cross Roller bearing is integrated with the output flange to provide high moment stiffness, high load capacity and precise positioning accuracy.

Easy mounting to a wide variety of servomotors

Quick Connect® motor adaptation system includes a clamshell style servo coupling and piloted adapter flange.

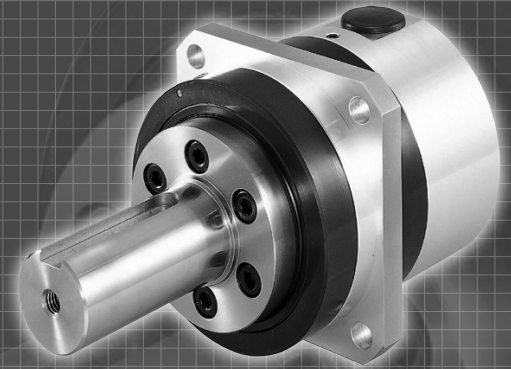

CONTENTS

| | |
|--|---------|
| Rating Table, Ratcheting Torque, Buckling Torque | 87 |
| Performance Table | 88 |
| Torsional Stiffness | 89 |
| Outline Dimensions | 90-94 |
| Rating Table Definitions, Life, Torque Limits | 106-107 |
| Torsional Stiffness, Vibration, Efficiency | 108-109 |
| Product Sizing & Selection | 110-111 |

CSG - 20 - 100 - GH - F0 - Motor Code

| Model Name | Size | Reduction Ratio | Model | Output Configuration | Input Configuration |
|--------------------------------------|------|-----------------------|--------------|--|---|
| HarmonicDrive® CSG High Torque | 14 | 50, 80, 100 | GH: Gearhead | F0: Flange output J2: Shaft output without key J6: Shaft output with key and center tapped hole | This code represents the motor mounting configuration. Please contact us for a unique part number based on the motor you are using. |
| | 20 | 50, 80, 100, 120, 160 | | | |
| | 32 | | | | |
| | 45 | | | | |
| | 65 | 80, 100, 120, 160 | | | |

Gearhead Construction

Figure 086-1

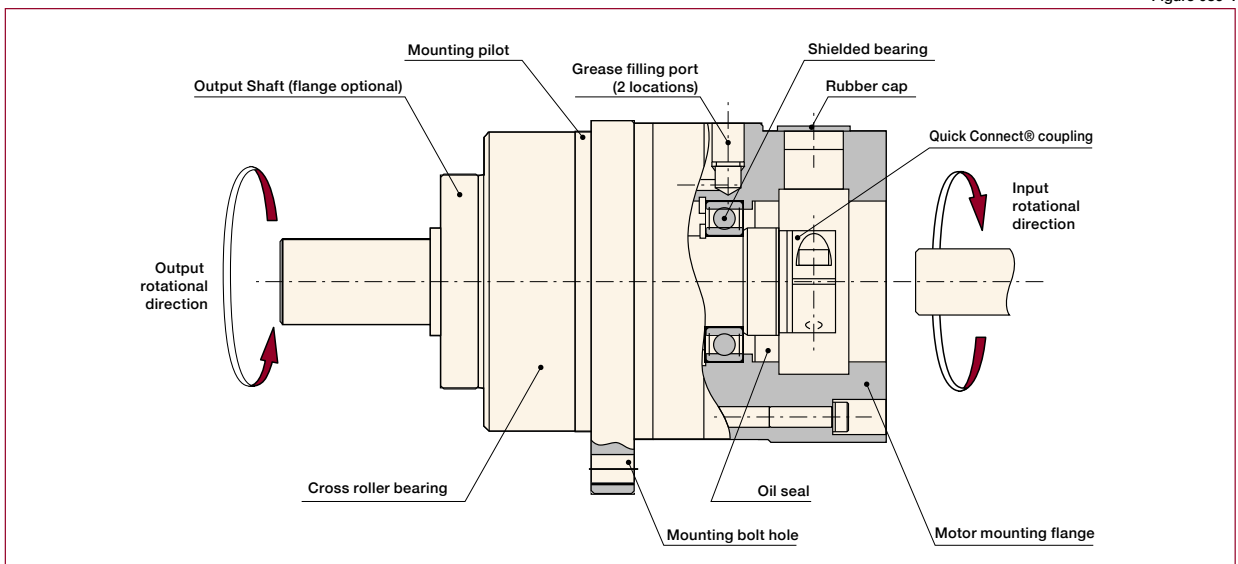

(The figure indicates output shaft type.)

Rating Table CSG-GH

Table 087-1

| Size | Ratio | Rated Torque at 2000 rpm *1 | Rated Torque at 3000 rpm *2 | Limit for Average Torque *3 | Limit for Repeated Peak Torque *4 | Limit for Momentary Torque *5 | Max. Average Input Speed *6 | Max. Input Speed *7 | Mass *8 | |
|------|-------|-----------------------------|-----------------------------|-----------------------------|-----------------------------------|-------------------------------|-----------------------------|---------------------|---------|--------|
| | | | | | | | | | Shaft | Flange |
| | | | | | | | | | Nm | Nm |
| 14 | 50 | 7.0 | 6.1 | 9.0 | 23 | 46 | 3500 | 8500 | 0.62 | 0.50 |
| | 80 | 10 | 8.7 | 14 | 30 | 61 | | | | |
| | 100 | 10 | 8.7 | 14 | 36 | 70 | | | | |
| 20 | 50 | 33 | 29 | 44 | 73 | 127 | 3500 | 6500 | 1.8 | 1.4 |
| | 80 | 44 | 38 | 61 | 96 | 165 | | | | |
| | 100 | 52 | 45 | 64 | 107 | 191 | | | | |
| | 120 | 52 | 45 | 64 | 113 | 191 | | | | |
| | 160 | 52 | 45 | 64 | 120 | 191 | | | | |
| 32 | 50 | 99 | 86 | 140 | 281 | 497 | 3500 | 4800 | 4.6 | 3.2 |
| | 80 | 153 | 134 | 217 | 395 | 738 | | | | |
| | 100 | 178 | 155 | 281 | 433 | 812 | | | | |
| | 120 | 178 | 155 | 281 | 459 | 812 | | | | |
| | 160 | 178 | 155 | 281 | 484 | 812 | | | | |
| 45 | 50 | 229 | 200 | 345 | 650 | 1235 | 3000 | 3800 | 13 | 10 |
| | 80 | 407 | 356 | 507 | 918 | 1651 | | | | |
| | 100 | 459 | 401 | 650 | 982 | 2033 | | | | |
| | 120 | 523 | 457 | 806 | 1070 | 2033 | | | | |
| | 160 | 523 | 457 | 819 | 1147 | 2033 | | | | |
| 65 | 80 | 969 | 846 | 1352 | 2743 | 4836 | 1900 | 2800 | 32 | 24 |
| | 100 | 1236 | 1080 | 1976 | 2990 | 5174 | | | | |
| | 120 | 1236 | 1080 | 2041 | 3263 | 5174 | | | | |
| | 160 | 1236 | 1080 | 2041 | 3419 | 5174 | | | | |

- *1: Rated torque is based on L10 life of 10,000 hours when input speed is 2000 rpm
- *2: Rated torque is based on L10 life of 10,000 hours when input speed is 3000 rpm, input rotational speed for size 65 is 2800 rpm.
- *3: Average load torque calculated based on the application motion profile must not exceed values shown in the table. See p. 102.
- *4: The limit for torque during start and stop cycles.
- *5: The limit for torque during emergency stops or from external shock loads. Always operate below this value.
- *6: Max value of average input rotational speed during operation.
- *7: Maximum instantaneous input speed.
- *8: The mass is for the gearhead only (without input shaft coupling & motor flange). Please contact us for the mass of your specific configuration.

Ratcheting Torque CSG-GH

(Unit: Nm) Table 087-2

| Ratio \ Size | 14 | 20 | 32 | 45 | 65 |
|--------------|-----|-----|------|------|-------|
| 50 | 110 | 280 | 1200 | 3500 | — |
| 80 | 140 | 450 | 1800 | 5000 | 14000 |
| 100 | 100 | 330 | 1300 | 4000 | 12000 |
| 120 | — | 310 | 1200 | 3600 | 10000 |
| 160 | — | 280 | 1200 | 3300 | 10000 |

Buckling Torque CSG-GH

(Unit: Nm) Table 087-3

| Size | 14 | 20 | 32 | 45 | 65 |
|------------|-----|-----|------|------|-------|
| All Ratios | 260 | 800 | 3500 | 8900 | 26600 |

Performance Table CSG-GH

Table 088-1

| Size | Flange Type | Ratio | Accuracy *1 | Repeatability *2 | Starting torque *3 | Backdriving torque *4 | No-load running torque *5 | | | | |
|--------------|---------------|-------|-------------|------------------|--------------------|-----------------------|---------------------------|----|-----|----|-----|
| | | | arc min | arc sec | Ncm | Nm | Ncm | | | | |
| 14 | All | 50 | 1.5 | ±10 | 8.5 | 3.0 | 5.6 | | | | |
| | | 80 | | | 7.1 | 4.0 | 5.1 | | | | |
| | | 100 | | | 6.8 | 4.9 | 4.6 | | | | |
| 20 | Type I | 50 | 1.0 | ±8 | 14 | 8 | 11 | | | | |
| | | 80 | | | 10 | 10 | 10 | | | | |
| | | 100 | | | 10 | 13 | 10 | | | | |
| | | 120 | | | 9.4 | 14 | 9.8 | | | | |
| | | 160 | | | 8.9 | 18 | 9.6 | | | | |
| | | 160 | | | 21 | 12 | 11 | | | | |
| | Type II & III | 80 | 1.0 | ±8 | 17 | 16 | 10 | | | | |
| | | 100 | | | 16 | 20 | 10 | | | | |
| | | 120 | | | 16 | 24 | 9.8 | | | | |
| | | 160 | | | 15 | 30 | 9.6 | | | | |
| | | 32 | | | Type II | 50 | 1.0 | ±6 | 61 | 37 | 47 |
| | | | | | | 80 | | | 48 | 46 | 42 |
| 100 | 47 | | 56 | 41 | | | | | | | |
| 120 | 43 | | 63 | 40 | | | | | | | |
| 160 | 42 | | 81 | 40 | | | | | | | |
| 160 | 53 | | 32 | 47 | | | | | | | |
| Type I & III | 80 | | 1.0 | ±6 | 40 | 39 | 42 | | | | |
| | 100 | | | | 39 | 47 | 41 | | | | |
| | 120 | | | | 35 | 51 | 40 | | | | |
| | 160 | | | | 34 | 66 | 40 | | | | |
| | 45 | | | | All | 50 | 1.0 | ±5 | 129 | 78 | 120 |
| | | | | | | 80 | | | 99 | 96 | 109 |
| 100 | | 93 | 111 | 107 | | | | | | | |
| 120 | | 88 | 128 | 105 | | | | | | | |
| 160 | | 82 | 158 | 103 | | | | | | | |
| 65 | All | 80 | 1.0 | ±4 | 197 | 191 | 297 | | | | |
| | | 100 | | | 176 | 213 | 289 | | | | |
| | | 120 | | | 165 | 240 | 285 | | | | |
| | | 160 | | | 147 | 285 | 278 | | | | |

*1: Accuracy values represent the difference between the theoretical angle and the actual angle of output for any given input. The values in the table are maximum values.

Figure 088-1

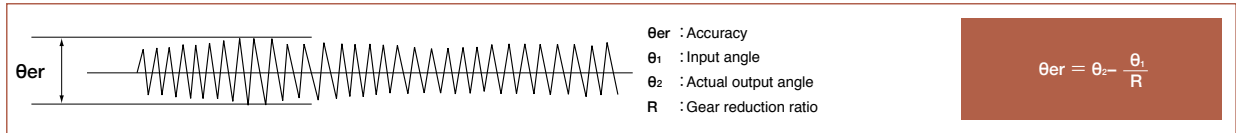

*2: The repeatability is measured by moving to a given theoretical position seven times, each time approaching from the same direction. The actual position of the output shaft is measured each time and repeatability is calculated as the 1/2 of the maximum difference of the seven data points. Measured values are indicated in angles (arc-sec) prefixed with "±". The values in the table are maximum values.

*3: Starting torque is the torque value applied to the input side at which the output first starts to rotate. The values in the table are maximum values.

Table 088-2

| Load | No load |
|-----------------------------------|---------|
| Speed reducer surface temperature | 25°C |

Figure 088-2

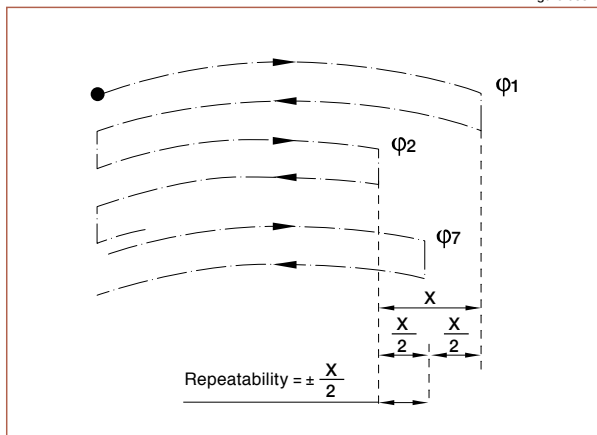

*4: Backdriving torque is the torque value applied to the output side at which the input first starts to rotate. The values in the table are maximum values.

Note: Never rely on these values as a margin in a system that must hold an external load. A brake must be used where back driving is not permissible.

Table 088-3

| Load | No load |
|-----------------------------------|---------|
| Speed reducer surface temperature | 25°C |

*5: No-load running torque is the torque required at the input to operate the gearhead at a given speed under a no-load condition. The values in the table are average values.

Table 088-4

| Input speed | 2000 rpm |
|-----------------------------------|----------|
| Load | No load |
| Speed reducer surface temperature | 25°C |

Torsional Stiffness CSG-GH

Table 089-1

| Symbol | | Size | 14 | 20 | 32 | 45 | 65 | |
|--------------------|----------------------------|-------------------------|-------------------------|------|------|------|------|----|
| T ₁ | | Nm | 2.0 | 7.0 | 29 | 76 | 235 | |
| | | kgfm | 0.2 | 0.7 | 3.0 | 7.8 | 24 | |
| T ₂ | | Nm | 6.9 | 25 | 108 | 275 | 843 | |
| | | kgfm | 0.7 | 2.5 | 11 | 28 | 86 | |
| Reduction ratio 50 | K ₁ | x10 ⁴ Nm/rad | 0.34 | 1.3 | 5.4 | 15 | — | |
| | | kgfm/arc min | 0.1 | 0.38 | 1.6 | 4.3 | — | |
| | K ₂ | x10 ⁴ Nm/rad | 0.47 | 1.8 | 7.8 | 20 | — | |
| | | kgfm/arc min | 0.14 | 0.52 | 2.3 | 6.0 | — | |
| | K ₃ | x10 ⁴ Nm/rad | 0.57 | 2.3 | 9.8 | 26 | — | |
| | | kgfm/arc min | 0.17 | 0.67 | 2.9 | 7.6 | — | |
| | θ ₁ | x10 ⁻² rad | 5.8 | 5.2 | 5.5 | 5.2 | — | |
| | | arc min | 2.0 | 1.8 | 1.9 | 1.8 | — | |
| | θ ₂ | x10 ⁻² rad | 16 | 15.4 | 15.7 | 15.1 | — | |
| | | arc min | 5.6 | 5.3 | 5.4 | 5.2 | — | |
| | Reduction ratio 80 or more | K ₁ | x10 ⁴ Nm/rad | 0.47 | 1.6 | 6.7 | 18 | 54 |
| | | | kgfm/arc min | 0.14 | 0.47 | 2.0 | 5.4 | 16 |
| K ₂ | | x10 ⁴ Nm/rad | 0.61 | 2.5 | 11 | 29 | 88 | |
| | | kgfm/arc min | 0.18 | 0.75 | 3.2 | 8.5 | 26 | |
| K ₃ | | x10 ⁴ Nm/rad | 0.71 | 2.9 | 12 | 33 | 98 | |
| | | kgfm/arc min | 0.21 | 0.85 | 3.7 | 9.7 | 29 | |
| θ ₁ | | x10 ⁻² rad | 4.1 | 4.4 | 4.4 | 4.1 | 4.4 | |
| | | arc min | 1.4 | 1.5 | 1.5 | 1.4 | 1.5 | |
| θ ₂ | | x10 ⁻² rad | 12 | 11.3 | 11.6 | 11.1 | 11.3 | |
| | | arc min | 4.2 | 3.9 | 4.0 | 3.8 | 3.9 | |

* The values in this table are average values. See page 108 for more information about torsional stiffness.

Hysteresis Loss CSG-GH

Reduction ratio 50: Approx. 5.8×10^{-4} rad (2arc min)
 Reduction ratio 80 or more: Approx. 2.9×10^{-4} rad (1arc min)

CSG-GH-14 Outline Dimensions

Only primary dimensions are shown in the drawings below. Refer to the confirmation drawing for detailed dimensions.

Figure 090-1

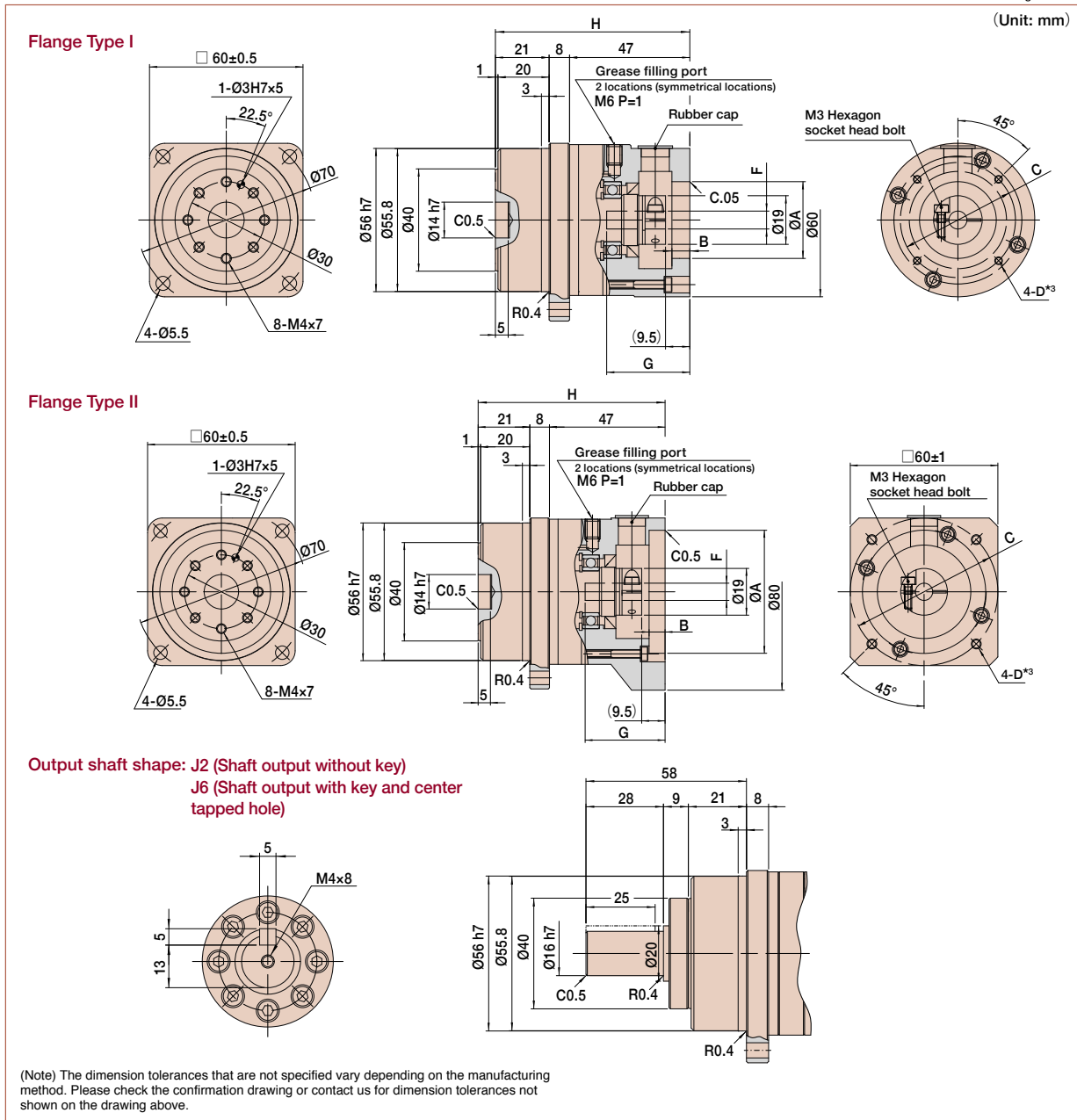

(Note) The dimension tolerances that are not specified vary depending on the manufacturing method. Please check the confirmation drawing or contact us for dimension tolerances not shown on the drawing above.

Dimension Table

(Unit: mm) Table 090-1

| Flange | Coupling | A (H7) ^{*1} | | B ^{*1} | C ^{*1} | | F (H7) ^{*1} | | G ^{*1} | | H ^{*1} | Moment of Inertia (10 ⁻⁴ kgm ²) | Mass (kg) ^{*2} | |
|---------|----------|----------------------|------|-----------------|-----------------|------|----------------------|------|-----------------|------|-----------------|---|-------------------------|--------|
| | | Min. | Max. | Max. | Min. | Max. | Min. | Max. | Min. | Max. | Typical | | Shaft | Flange |
| Type I | 1 | 30 | 50 | 6.5 | 35 | 55 | 6.0 | 8 | 20.5 | 32.5 | 76 | 0.07 | 0.88 | 0.76 |
| Type II | 1 | 50 | 55 | 7 | 55 | 75 | 6.0 | 8 | 20.5 | 32.5 | 76 | 0.07 | 0.90 | 0.78 |

Refer to the confirmation drawing for detailed dimensions.

Dimensions of typical products are shown. Please contact us for other mounting options if the configurations shown above are not suitable for your particular motor.

*1 May vary depending on motor interface dimensions.

*2 The mass will vary slightly depending on the ratio and on the inside diameter of the input shaft coupling.

*3 Tapped hole for motor mounting screw.

CSG-GH-20 Outline Dimensions

Only primary dimensions are shown in the drawings below. Refer to the confirmation drawing for detailed dimensions.

Figure 091-1

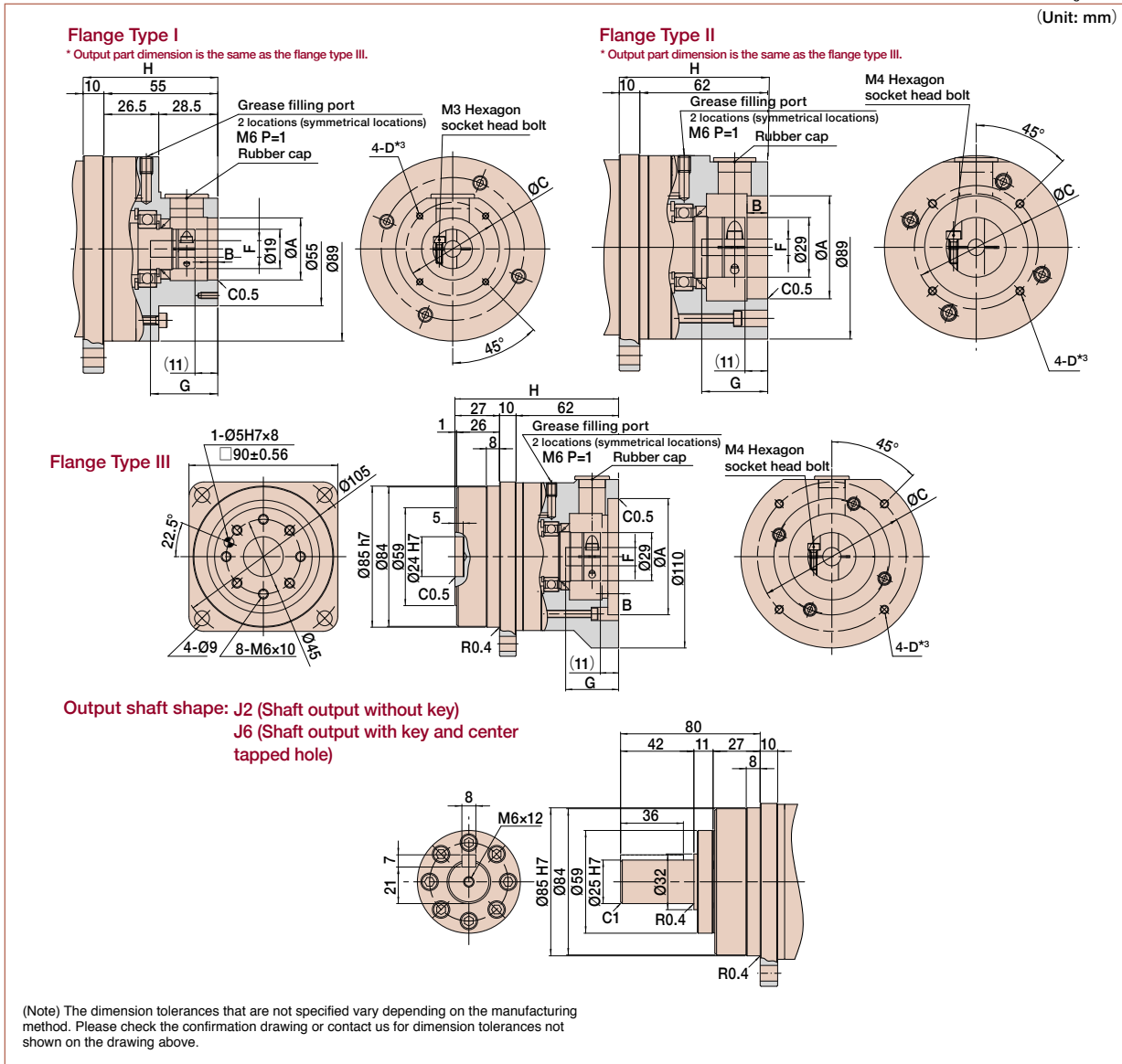

CSG-GH Series HarmonicDrive High-Performance Gearhead for Servomotors

Dimension Table

(Unit: mm) Table 091-1

| Flange | Coupling | A (H7) ¹ | | B ¹ | C ¹ | | F (H7) ¹ | | G ¹ | | H ¹ | Moment of Inertia | Mass (kg) ² | |
|----------|----------|---------------------|------|----------------|----------------|------|---------------------|------|----------------|------|----------------|--------------------------------------|------------------------|--------|
| | | Min. | Max. | Max. | Min. | Max. | Min. | Max. | Min. | Max. | Typical | (10 ⁻⁴ kgm ²) | Shaft | Flange |
| Type I | 1 | 30 | 45 | 5 | 35 | 50 | 7.0 | 7.8 | 22.0 | 33.0 | 92.0 | 0.28 | 2.3 | 1.9 |
| Type II | 2 | 50 | 79 | 10 | 55 | 84 | 8.0 | 14.6 | 24.0 | 32.0 | 99.0 | 0.42 | 2.6 | 2.2 |
| Type III | 2 | 50 | 100 | 10 | 55 | 105 | 8.0 | 14.6 | 24.0 | 32.0 | 99.0 | 0.42 | 2.8 | 2.4 |

Refer to the confirmation drawing for detailed dimensions.

Dimensions of typical products are shown. Please contact us for other mounting options if the configurations shown above are not suitable for your particular motor.

*1 May vary depending on motor interface dimensions.

*2 The mass will vary slightly depending on the ratio and on the inside diameter of the input shaft coupling.

*3 Tapped hole for motor mounting screw.

CSG-GH-32 Outline Dimensions

Only primary dimensions are shown in the drawings below. Refer to the confirmation drawing for detailed dimensions.

Figure 092-1

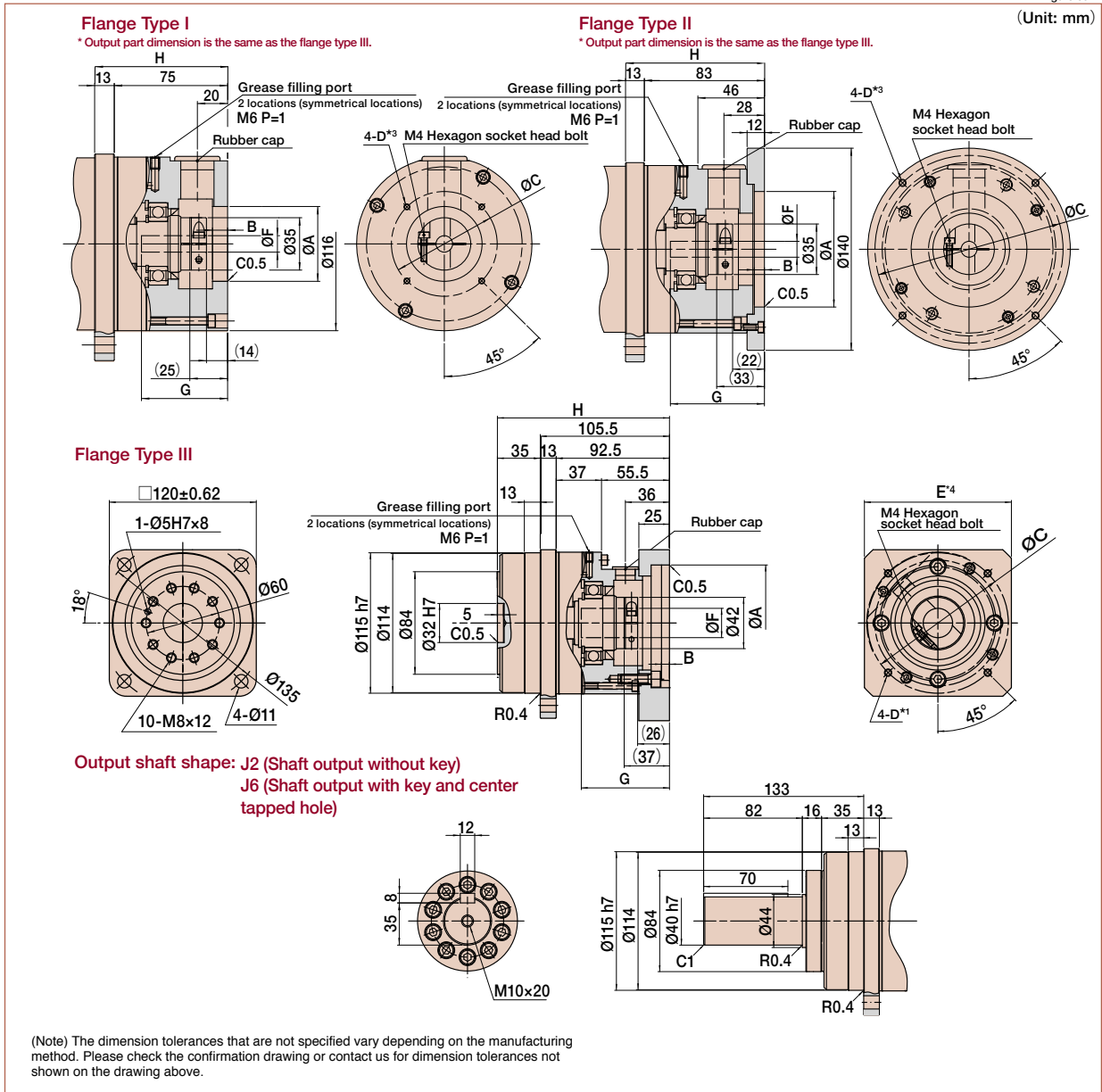

Dimension Table

(Unit: mm) Table 092-1

| Flange | Coupling | A (H7) ⁻¹ | | B ⁻¹ | C ⁻¹ | | F (H7) ⁻¹ | | G ⁻¹ | | H ⁻¹ | Moment of Inertia (10 ⁻⁴ kgm ²) | Mass (kg) ⁻² | |
|----------|----------|----------------------|-------------------|-----------------|-----------------|-------------------|----------------------|------|-----------------|------|-----------------|---|-------------------------|--------|
| | | Min. | Max. | Max. | Min. | Max. | Min. | Max. | Min. | Max. | Max. | | Shaft | Flange |
| Type I | 1 | 50 | 105 | 10 | 55 | 110 | 10.8 | 19.6 | 27.0 | 57 | 123 | 2.7 | 6.4 | 5.0 |
| | 3 | | | | | | 8.8 | 19.6 | 27.0 | 57 | | | 6.4 | 5.0 |
| Type II | 2 | 60 | 175 ^{*1} | 5 | 70 | 225 ^{*1} | 16.0 | 25.8 | 39.0 | 72 | 140.5 | 2.7 | 7.9 | 6.5 |
| Type III | 1 | 35 | 130 ^{*1} | 7 | 40 | 135 ^{*1} | 10.8 | 19.6 | 35.0 | 65 | 131 | 2.0 | 6.6 | 5.2 |
| | 3 | | | | | | 8.8 | 19.6 | 35.0 | 65 | | | 6.6 | 5.2 |

Refer to the confirmation drawing for detailed dimensions.

Dimensions of typical products are shown. Please contact us for other mounting options if the configurations shown above are not suitable for your particular motor.

^{*1} May vary depending on motor interface dimensions.

^{*2} The mass will vary slightly depending on the ratio and on the inside diameter of the input shaft coupling.

^{*3} Tapped hole for motor mounting screw.

CSG-GH-45 Outline Dimensions

Only primary dimensions are shown in the drawings below. Refer to the confirmation drawing for detailed dimensions.

Figure 093-1

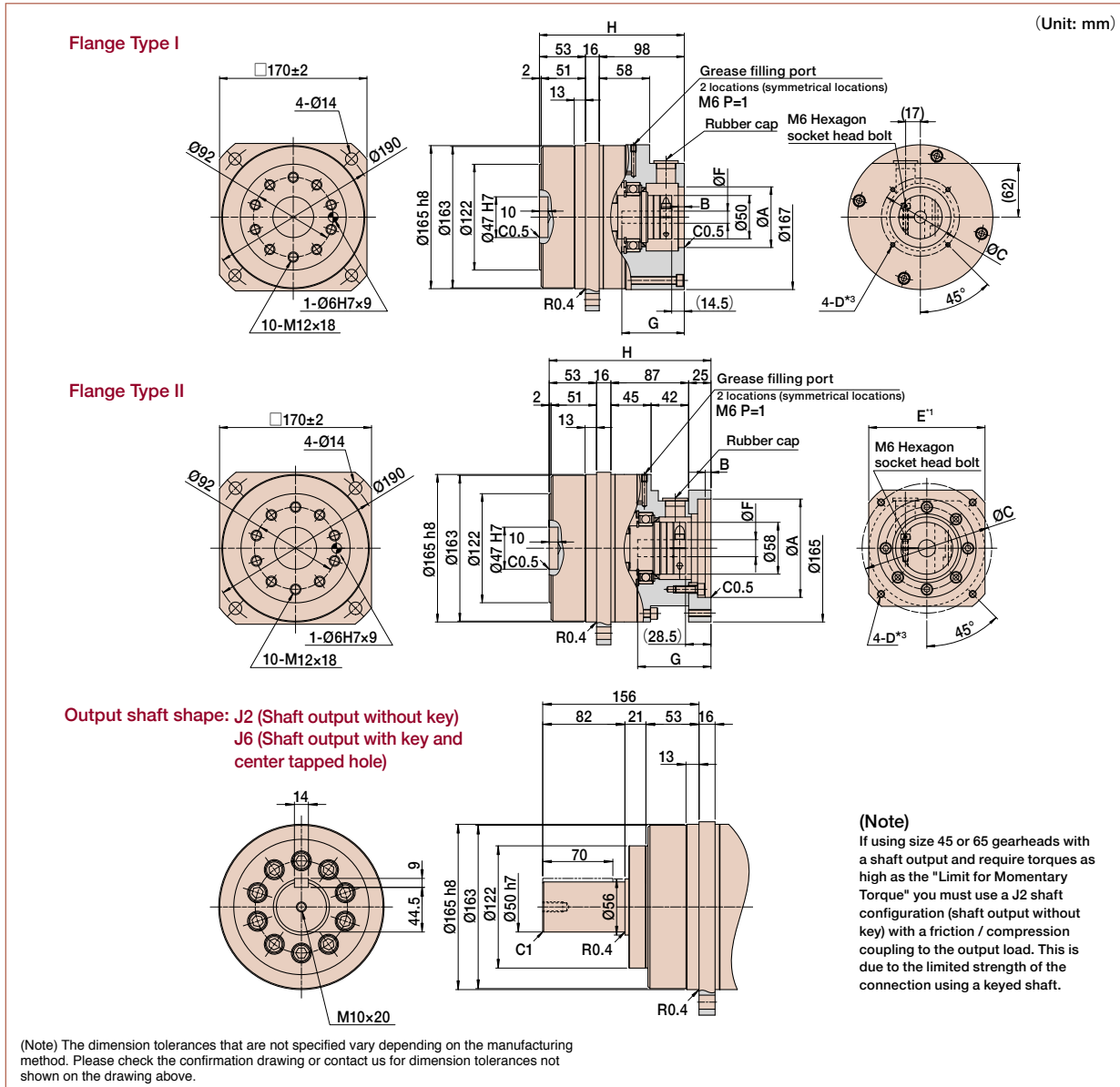

Dimension Table

(Unit: mm) Table 093-1

| Flange | Coupling | A (H7) *1 | | B *1 | C *1 | | F (H7) *1 | | G *1 | | H *1 | Moment of Inertia (10 ⁻⁴ kgm ²) | Mass (kg) *2 | |
|---------|----------|-----------|--------|------|------|--------|-----------|------|------|------|---------|---|--------------|--------|
| | | Min. | Max. | Max. | Min. | Max. | Min. | Max. | Min. | Max. | Typical | | Shaft | Flange |
| Type I | 1 | 70 | 119 | 7 | 80 | 157 | 14.0 | 29.4 | 30.5 | 72 | 167 | 11 | 17.3 | 14.3 |
| | 2 | 70 | 119 | 7 | 80 | 157 | 19.0 | 41 | 30.5 | 68 | 167 | 11 | 17.3 | 14.3 |
| Type II | 1 | 70 | 175 *1 | 6.5 | 80 | 225 *1 | 14.0 | 29.4 | 44.5 | 86 | 181 | 11 | 17.7 | 14.7 |
| | 2 | 70 | 175 *1 | 6.5 | 80 | 225 *1 | 19.0 | 41 | 44.5 | 82 | 181 | 11 | 17.7 | 14.7 |

Refer to the confirmation drawing for detailed dimensions.

Dimensions of typical products are shown. Please contact us for other mounting options if the configurations shown above are not suitable for your particular motor.

*1 May vary depending on motor interface dimensions.

*2 The mass will vary slightly depending on the ratio and on the inside diameter of the input shaft coupling.

*3 Tapped hole for motor mounting screw.

CSG-GH-65 Outline Dimensions

Only primary dimensions are shown in the drawings below. Refer to the confirmation drawing for detailed dimensions.

Figure 094-1

(Unit: mm)

Flange Type I

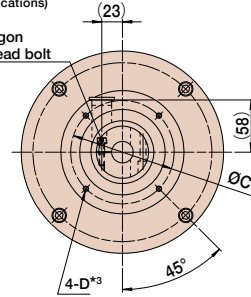
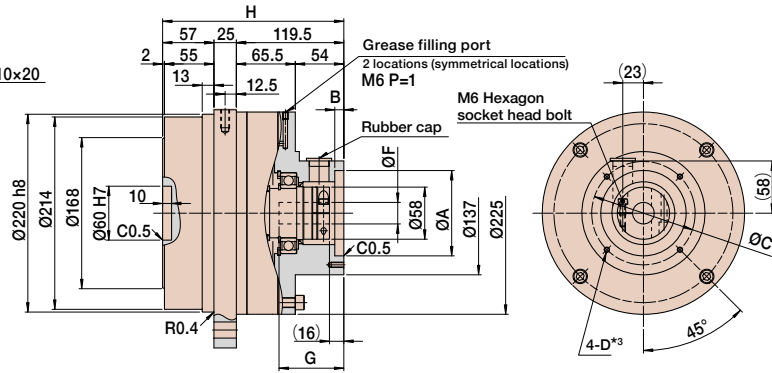
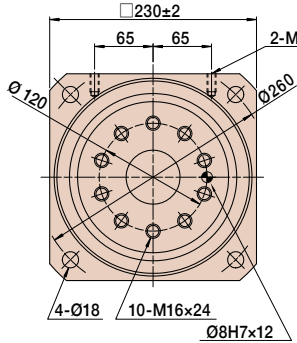

Flange Type II

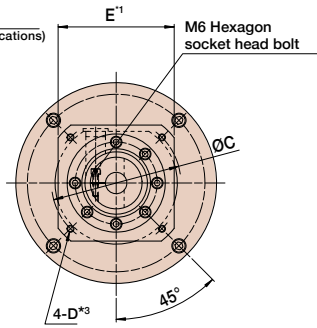
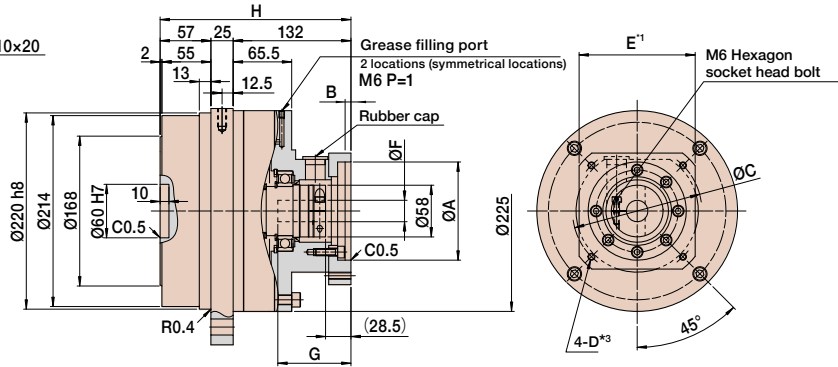
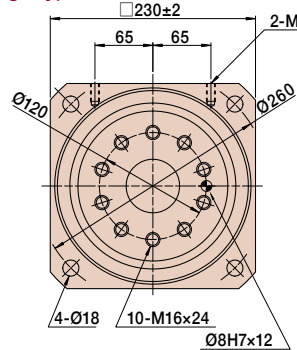

Output shaft shape: J2 (Shaft output without key)
J6 (Shaft output with key and center tapped hole)

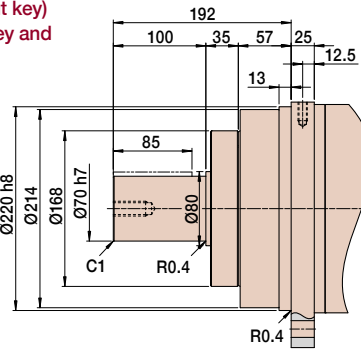
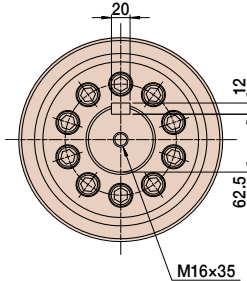

(Note)

If using size 45 or 65 gearheads with a shaft output and required torques are as high as the "Limit for Momentary Torque," you must use a J2 shaft configuration (shaft output without key) with a friction / compression coupling to the output load. This is due to the limited strength of the connection using a keyed shaft.

(Note) The dimension tolerances that are not specified vary depending on the manufacturing method. Please check the confirmation drawing or contact us for dimension tolerances not shown on the drawing above.

Dimension Table

(Unit: mm) Table 094-1

| Flange | Coupling | A (H7) ^{*1} | | B ^{*1} | C ^{*1} | | F (H7) ^{*1} | | G ^{*1} | | H ^{*1} | Moment of Inertia (10 ⁻⁴ kgm ²) | Mass (kg) ^{*2} | |
|---------|----------|----------------------|-------------------|-----------------|-----------------|-------------------|----------------------|------|-----------------|------|-----------------|---|-------------------------|--------|
| | | Min. | Max. | Max. | Min. | Max. | Min. | Max. | Min. | Max. | Max. | | Shaft | Flange |
| Type I | 1 | 95 | 110 | 10 | 105 | 125 | 19.0 | 39.3 | 32.0 | 72 | 201.5 | 51 | 36.2 | 27.6 |
| Type II | 1 | 70 | 215 ^{*1} | 6.5 | 80 | 260 ^{*1} | 19.0 | 39.3 | 44.5 | 84.5 | 214 | 51 | 38.3 | 29.7 |

Refer to the confirmation drawing for detailed dimensions.

Dimensions of typical products are shown. Please contact us for other mounting options if the configurations shown above are not suitable for your particular motor.

*1 May vary depending on motor interface dimensions.

*2 The mass will vary slightly depending on the ratio and on the inside diameter of the input shaft coupling.

*3 Tapped hole for motor mounting screw.

Rating Table Definitions

See the corresponding pages of each series for values from the ratings.

Rated torque

Rated torque indicates allowable continuous load torque at input speed.

Limit for Repeated Peak Torque

(see Graph 106-1)

During acceleration and deceleration the Harmonic Drive® gear experiences a peak torque as a result of the moment of inertia of the output load. The table indicates the limit for repeated peak torque.

Limit for Average Torque

In cases where load torque and input speed vary, it is necessary to calculate an average value of load torque. The table indicates the limit for average torque. The average torque calculated must not exceed this limit. (calculation formula: Page 111)

Limit for Momentary Torque

(see Graph 106-1)

The gear may be subjected to momentary torques in the event of a collision or emergency stop. The magnitude and frequency of occurrence of such peak torques must be kept to a minimum and they should, under no circumstance, occur during normal operating cycle. The allowable number of occurrences of the momentary torque may be calculated by using the formula on page 111.

Maximum Average Input Speed

Maximum Input Speed

Do not exceed the allowable rating. (calculation formula of the average input speed: Page 111).

Inertia

The rating indicates the moment of inertia reflected to the gear input.

Example of load torque pattern

Graph 106-1

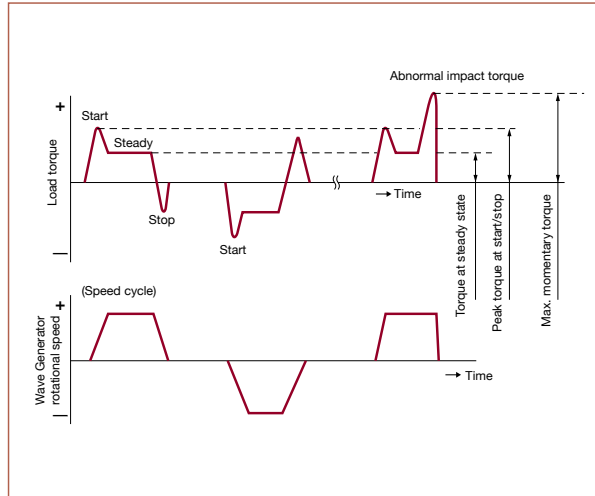

Life

Life of the wave generator

The life of a gear is determined by the life of the wave generator bearing. The life may be calculated by using the input speed and the output load torque.

Table 106-1

| Series name | Life | |
|--------------------------------|--------------|--------------|
| | CSF-GH | CSG-GH |
| L ₁₀ | 7,000 hours | 10,000 hours |
| L ₅₀ (average life) | 35,000 hours | 50,000 hours |

* Life is based on the input speed and output load torque from the ratings.

Calculation formula for Rated Lifetime

Formula 106-1

$$L_h = L_n \cdot \left(\frac{T_r}{T_{av}} \right)^3 \cdot \left(\frac{N_r}{N_{av}} \right)$$

Table 106-2

| | |
|-----------------|--|
| L _n | Life of L ₁₀ or L ₅₀ |
| T _r | Rated torque |
| N _r | Rated input speed |
| T _{av} | Average load torque on the output side (calculation formula: Page 111) |
| N _{av} | Average input speed (calculation formula: Page 111) |

Relative torque rating

Graph 106-2

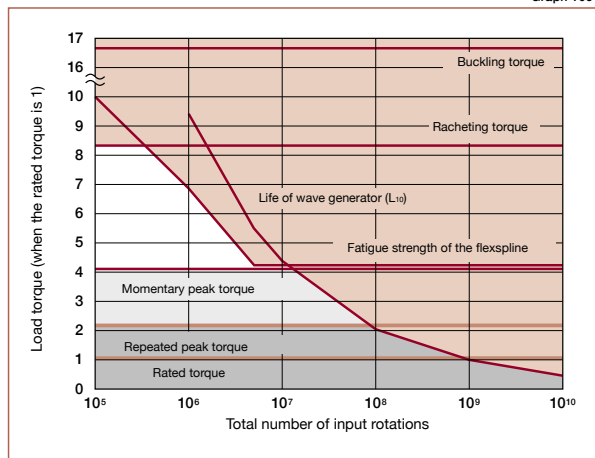

* Lubricant life not taken into consideration in the graph described above.

* Use the graph above as reference values.

Torque Limits

Strength of flexspline

The Flexspline is subjected to repeated deflections, and its strength determines the torque capacity of the Harmonic Drive® gear. The values given for Rated Torque at Rated Speed and for the allowable Repeated Peak Torque are based on an infinite fatigue life for the Flexspline.

The torque that occurs during a collision must be below the momentary torque (impact torque). The maximum number of occurrences is given by the equation below.

Allowable limit of the bending cycles of the flexspline during rotation of the wave generator while the impact torque is applied: 1.0×10^4 (cycles)

The torque that occurs during a collision must be below the momentary torque (impact torque). The maximum number of occurrences is given by the equation below.

Calculation formula

Formula 107-1

$$N = \frac{1.0 \times 10^4}{2 \times \frac{n}{60} \times t}$$

| | |
|--|---------------|
| Permissible occurrences | N occurrences |
| Time that impact torque is applied | t sec |
| Rotational speed of the wave generator | n rpm |
| The flexspline bends two times per one revolution of the wave generator. | |



If the number of occurrences is exceeded, the Flexspline may experience a fatigue failure.

Buckling torque

When a highly excessive torque (16 to 17 times rated torque) is applied to the output with the input stationary, the flexspline may experience elastic deformation. This is defined as buckling torque.

* See the corresponding pages of each series for buckling torque values.



When the flexspline buckles, early failure of the Harmonic Drive® gear may occur.

Ratcheting torque

When excessive torque (8 to 9 times rated torque) is applied while the gear is in motion, the teeth between the Circular Spline and Flexspline may not engage properly.

This phenomenon is called ratcheting and the torque at which this occurs is called ratcheting torque. Ratcheting may cause the Flexspline to become non-concentric with the Circular Spline. Operating in this condition may result in shortened life and a Flexspline fatigue failure.

* See the corresponding pages of each series for ratcheting torque values.

* Ratcheting torque is affected by the stiffness of the housing to be used when installing the circular spline. Contact us for details of the ratcheting torque.



When ratcheting occurs, the teeth may not be correctly engaged and become out of alignment as shown in Figure 099-1. Operating the drive in this condition will cause vibration and damage the flexspline.



Once ratcheting occurs, the teeth wear excessively and the ratcheting torque may be lowered.

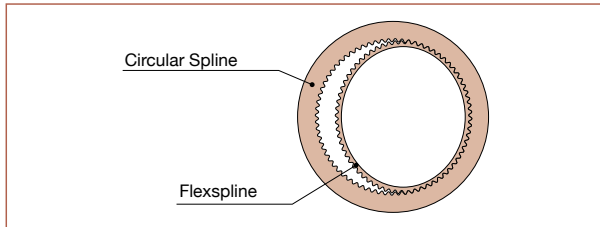

Figure 107-1

"Dedoidal" condition.

Torsional Stiffness

Stiffness and backlash of the drive system greatly affects the performance of the servo system. Please perform a detailed review of these items before designing your equipment and selecting a model number.

Stiffness

Fixing the input side (wave generator) and applying torque to the output side (flexspline) generates torsion almost proportional to the torque on the output side. Figure 106-1 shows the torsional angle at the output side when the torque applied on the output side starts from zero, increases up to $+T_0$ and decreases down to $-T_0$. This is called the "Torque – torsion angle diagram," which normally draws a loop of $0 - A - B - A' - B' - A$. The slope described in the "Torque – torsion angle diagram" is represented as the spring constant for the stiffness of the HarmonicDrive® gear (unit: Nm/rad).

As shown in Figure 108-2, this "Torque – torsional angle diagram" is divided into 3 regions, and the spring constants in the area are represented by K_1 , K_2 and K_3 .

- K_1 ... The spring constant when the torque changes from [zero] to $[T_1]$
- K_2 ... The spring constant when the torque changes from $[T_1]$ to $[T_2]$
- K_3 ... The spring constant when the torque changes from $[T_2]$ to $[T_3]$

- See the corresponding pages of each series for values of the spring constants (K_1 , K_2 , K_3) and the torque-torsional angles (T_1 , T_2 , θ_1 , θ_2).

Example for calculating the torsion angle

The torsion angle (θ) is calculated here using CSG-32-100-GH as an example.

$$\begin{aligned} T_1 &= 29 \text{ Nm} \\ T_2 &= 108 \text{ Nm} \\ K_1 &= 11 \times 10^4 \text{ Nm/rad} \\ K_2 &= 12 \times 10^4 \text{ Nm/rad} \\ K_3 &= 6.7 \times 10^4 \text{ Nm/rad} \\ \theta_1 &= 4.4 \times 10^{-4} \text{ rad} \\ \theta_2 &= 11.6 \times 10^{-4} \text{ rad} \end{aligned}$$

When the applied torque is T_1 or less, the torsion angle θ_{L1} is calculated as follows:

$$\begin{aligned} \text{When the load torque } T_{L1} &= 6.0 \text{ Nm} \\ \theta_{L1} &= T_{L1}/K_1 \\ &= 6.0/6.7 \times 10^4 \\ &= 9.0 \times 10^{-5} \text{ rad (0.31 arc min)} \end{aligned}$$

When the applied torque is between T_1 and T_2 , the torsion angle θ_{L2} is calculated as follows:

$$\begin{aligned} \text{When the load torque is } T_{L2} &= 50 \text{ Nm} \\ \theta_{L2} &= \theta_1 + (T_{L2} - T_1)/K_2 \\ &= 4.4 \times 10^{-4} + (50 - 29)/11.0 \times 10^4 \\ &= 4.4 \times 10^{-4} + 1.9 \times 10^{-4} \\ &= 6.3 \times 10^{-4} \text{ rad (2.17 arc min)} \end{aligned}$$

When the applied torque is greater than T_2 , the torsion angle θ_{L3} is calculated as follows:

$$\begin{aligned} \text{When the load torque is } T_{L3} &= 178 \text{ Nm} \\ \theta_{L3} &= \theta_1 + \theta_2 + (T_{L3} - T_2)/K_3 \\ &= 4.4 \times 10^{-4} + 11.6 \times 10^{-4} + (178 - 108)/12.0 \times 10^4 \\ &= 4.4 \times 10^{-4} + 11.6 \times 10^{-4} + 5.8 \times 10^{-4} \\ &= 2.18 \times 10^{-3} \text{ rad (7.5 arc min)} \end{aligned}$$

When a bidirectional load is applied, the total torsion angle will be $2 \times \theta_{Lx}$ plus hysteresis loss.

* The torsion angle calculation is for the gear component set only and does not include any torsional windup of the output shaft.

Hysteresis loss

As shown in Figure 106-1, when the applied torque is increased to the rated torque and is brought back to [zero], the torsional angle does not return exactly back to the zero point. This small difference ($B - B'$) is called hysteresis loss.

- See the appropriate page for each model series for the hysteresis loss value.

Torque - torsion angle diagram

Figure 108-1

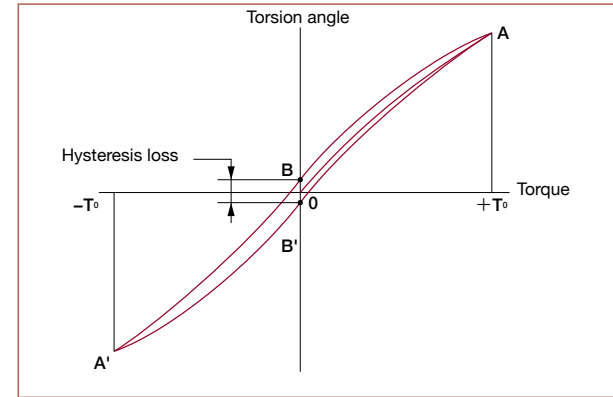

Spring constant diagram

Figure 108-2

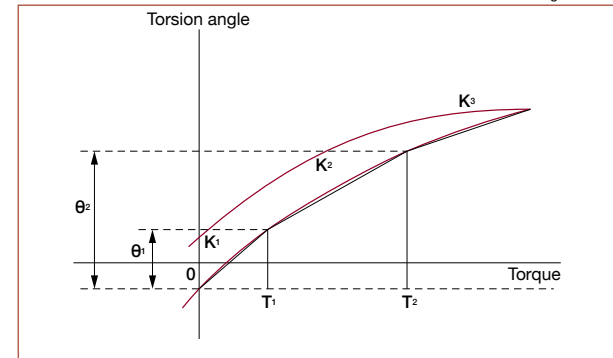

Backlash

Hysteresis loss is primarily caused by internal friction. It is a very small value and will vary roughly in proportion to the applied load. Because HarmonicDrive® gearheads have zero backlash, the only true backlash is due to the clearance in the Oldham coupling, a self-aligning mechanism used on the wave generator. Since the Oldham coupling is used on the input, the backlash measured at the output is extremely small (arc-seconds) since it is divided by the gear reduction ratio.

Vibration

The primary frequency of the transmission error of the HarmonicDrive® gear may rarely cause a vibration of the load inertia. This can occur when the driving frequency of the servo system including the HarmonicDrive® gear is at, or close to the resonant frequency of the system. Refer to the design guide of each series.

The primary component of the transmission error occurs twice per input revolution of the input. Therefore, the frequency generated by the transmission error is 2x the input frequency (rev / sec).

If the resonant frequency of the entire system, including the HarmonicDrive® gear, is F=15 Hz, then the input speed (N) which would generate that frequency could be calculated with the formula below.

Formula 109-1

$$N = \frac{15}{2} \cdot 60 = 450 \text{ rpm}$$

The resonant frequency is generated at an input speed of 450 rpm.

How to the calculate resonant frequency of the system

Formula 109-2

$$f = \frac{1}{2\pi} \sqrt{\frac{K}{J}}$$

Formula variables

Table 109-1

| | | | |
|---|--------------------------------------|------------------|---------------------------|
| f | The resonant frequency of the system | Hz | |
| K | Spring constant | Nm/rad | See pages of each series. |
| J | Load inertia | kgm ² | |

Efficiency

The efficiency will vary depending on the following factors:

- Reduction ratio
- Input speed
- Load torque
- Temperature
- Lubrication condition (Type of lubricant and the quantity)

Product Sizing & Selection

In general, a servo system rarely operates at a continuous load and speed. The input rotational speed, load torque change and comparatively large torque are applied at start and stop. Unexpected impact torque may be applied.

These fluctuating load torques should be converted to the average load torque when selecting a model number.

As an accurate cross roller bearing is built in the direct external load support (output flange), the maximum moment load, life of the cross roller bearing and the static safety coefficient should also be checked.

(Note) If HarmonicDrive® CSG-GH or CSF-GH series is installed vertically with the output shaft facing downward (motor mounted above it) and continuously operated in one direction under the constant load state, lubrication failure may occur. In this case, please contact us for details.

Application Motion Profile

Review the application motion profile. Check the specifications shown in the figure below.

Graph 110-1

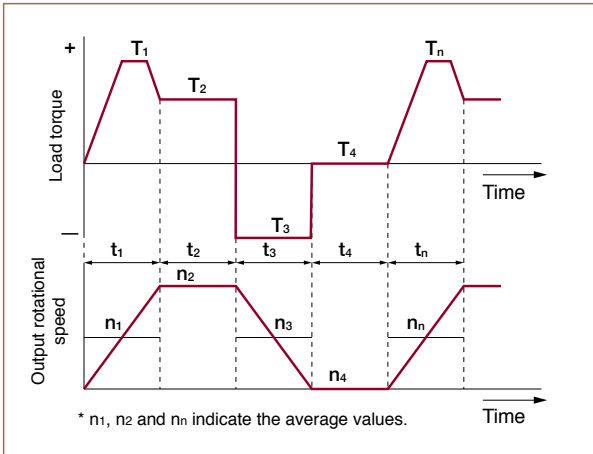

Obtain the value of each application motion profile.

| | |
|-------------------------|-------------|
| Load torque | T_n (Nm) |
| Time | t_n (sec) |
| Output rotational speed | n_n (rpm) |

Normal operation pattern

| | |
|--------------------------------------|-----------------|
| Starting (acceleration) | T_1, t_1, n_1 |
| Steady operation (constant velocity) | T_2, t_2, n_2 |
| Stopping (deceleration) | T_3, t_3, n_3 |
| Idle | T_4, t_4, n_4 |

Maximum rotational speed

| | |
|--|------------|
| Max. output speed | no_{max} |
| Max. input rotational speed (Restricted by motors) | ni_{max} |

Emergency stop torque

| | |
|-------------------------------|-----------------|
| When impact torque is applied | T_s, t_s, n_s |
|-------------------------------|-----------------|

Required life

$L_{10} = L$ (hours)

Flowchart for selecting a size

Please use the flowchart shown below for selecting a size. Operating conditions must not exceed the performance ratings.

Calculate the average load torque applied on the output side from the load torque pattern: T_{av} (Nm).

$$T_{av} = \sqrt[3]{\frac{n_1 \cdot t_1 \cdot |T_1|^3 + n_2 \cdot t_2 \cdot |T_2|^3 + \dots + n_n \cdot t_n \cdot |T_n|^3}{n_1 \cdot t_1 + n_2 \cdot t_2 + \dots + n_n \cdot t_n}}$$

Make a preliminary model selection with the following conditions.

$T_{av} \leq$ Limit for average torque
(See the ratings of each series).

Calculate the average output speed: no_{av} (rpm)

$$no_{av} = \frac{n_1 \cdot t_1 + n_2 \cdot t_2 + \dots + n_n \cdot t_n}{t_1 + t_2 + \dots + t_n}$$

Obtain the reduction ratio (R). A limit is placed on "ni max" by motors.

$$\frac{ni_{max}}{no_{max}} \geq R$$

Calculate the average input rotational speed from the average output rotational speed (no_{av}) and the reduction ratio (R): ni_{av} (rpm)

$$ni_{av} = no_{av} \cdot R$$

Calculate the maximum input rotational speed from the max. output rotational speed (no_{max}) and the reduction ratio (R): ni_{max} (rpm)

$$ni_{max} = no_{max} \cdot R$$

Check whether the preliminary model number satisfies the following condition from the ratings.

$$ni_{av} \leq \text{Limit for average speed (rpm)}$$

$$ni_{max} \leq \text{Limit for maximum speed (rpm)}$$

NG

OK

Check whether T_1 and T_3 are equal to or less than the repeated peak torque specification.

NG

OK

Check whether T_s is equal to or less than the the momentary torque specification.

NG

OK

Calculate (N_s) the allowable number of rotations during impact torque.

$$N_s = \frac{10^4}{2 \cdot \frac{n_s \cdot R}{60} \cdot t} \dots \dots N_s \leq 1.0 \times 10^4$$

NG

OK

Calculate the lifetime.

$$L_{10} = 7,000 \cdot \left(\frac{Tr}{T_{av}} \right)^3 \cdot \left(\frac{nr}{ni_{av}} \right) \text{ (hours)}$$

Check whether the calculated lifetime is equal to or more than the life of the wave generator (see Page 106).

NG

OK

The model number is confirmed.

Review the operation conditions and model number

Example of model number selection

| | | | |
|---|---|---|--|
| Load torque | T _n (Nm) | Maximum rotational speed | |
| Time | t _n (sec) | Max. output rotational speed | n _{o max} = 14 rpm |
| Output rotational speed | n _n (rpm) | Max. input rotational speed (Restricted by motors) | n _{i max} = 1800 rpm |
| Normal operation pattern | | Emergency stop torque | |
| Starting (acceleration) | T ₁ = 400 Nm, t ₁ = 0.3 sec, n ₁ = 7 rpm | When impact torque is applied | T _s = 500 Nm, t _s = 0.15 sec, n _s = 14 rpm |
| Steady operation (constant velocity) | T ₂ = 320 Nm, t ₂ = 3 sec, n ₂ = 14 rpm | Required life | |
| Stopping (deceleration) | T ₃ = 200 Nm, t ₃ = 0.4 sec, n ₃ = 7 rpm | L ₁₀ = 7000 (hours) | |
| Dwell Idle | T ₄ = 0 Nm, t ₄ = 0.2 sec, n ₄ = 0 rpm | | |

Calculate the average load torque applied on the output side of the Harmonic Drive® gear from the load torque pattern: **T_{av}** (Nm).

$$T_{av} = 3 \sqrt{\frac{7 \text{ rpm} \cdot 0.3 \text{ sec} \cdot |400 \text{ Nm}|^3 + 14 \text{ rpm} \cdot 3 \text{ sec} \cdot |320 \text{ Nm}|^3 + 7 \text{ rpm} \cdot 0.4 \text{ sec} \cdot |200 \text{ Nm}|^3}{7 \text{ rpm} \cdot 0.3 \text{ sec} + 14 \text{ rpm} \cdot 3 \text{ sec} + 7 \text{ rpm} \cdot 0.4 \text{ sec}}}$$

Make a preliminary model selection with the following conditions. **T_{av}** = 319 Nm ≤ 620 Nm
(Limit for average torque for model number CSF-45-120-GH: See the ratings on Page 97.)
Thus, **CSF-45-120-GH** is tentatively selected.

Calculate the average output rotational speed: n_{o av} (rpm)

$$n_{o \text{ av}} = \frac{7 \text{ rpm} \cdot 0.3 \text{ sec} + 14 \text{ rpm} \cdot 3 \text{ sec} + 7 \text{ rpm} \cdot 0.4 \text{ sec}}{0.3 \text{ sec} + 3 \text{ sec} + 0.4 \text{ sec} + 0.2 \text{ sec}} = 12 \text{ rpm}$$

Obtain the reduction ratio (R).

$$\frac{1800 \text{ rpm}}{14 \text{ rpm}} = 128.6 \geq 120$$

Calculate the average input rotational speed from the average output rotational speed (n_{o av}) and the reduction ratio (R): n_{i av} (rpm)

$$n_{i \text{ av}} = 12 \text{ rpm} \cdot 120 = 1440 \text{ rpm}$$

Calculate the maximum input rotational speed from the maximum output rotational speed (n_{o max}) and the reduction ratio (R): n_{i max} (rpm)

$$n_{i \text{ max}} = 14 \text{ rpm} \cdot 120 = 1680 \text{ rpm}$$

Check whether the preliminary selected model number satisfies the following condition from the ratings.

n_{i av} = 1440 rpm ≤ 3000 rpm (Max average input speed of size 45)
n_{i max} = 1680 rpm ≤ 3800 rpm (Max input speed of size 45)

OK

NG

Check whether T₁ and T₃ are equal to or less than the repeated peak torque specification.

T₁ = 400 Nm ≤ 823 Nm (Limit of repeated peak torque of size 45)
T₃ = 200 Nm ≤ 823 Nm (Limit of repeated peak torque of size 45)

OK

NG

Check whether T_s is equal to or less than the momentary torque specification.

T_s = 500 Nm ≤ 1760 Nm (Limit for momentary torque of size 45)

OK

NG

Calculate the allowable number (N_s) rotation during impact torque and confirm ≤ 1.0 × 10⁴

$$N_s = \frac{10^4}{2 \cdot \frac{14 \text{ rpm} \cdot 120}{60} \cdot 0.15 \text{ sec}} = 1190 \leq 1.0 \times 10^4$$

OK

NG

Calculate the lifetime.

$$L_{10} = 7000 \cdot \left(\frac{402 \text{ Nm}}{319 \text{ Nm}} \right)^3 \cdot \left(\frac{2000 \text{ rpm}}{1440 \text{ rpm}} \right) \text{ (hours)}$$

Check whether the calculated life is equal to or more than the life of the wave generator (see Page 106).

L₁₀ = 19,457 hours ≥ 7000 (life of the wave generator: L₁₀)

OK

NG

The selection of model number **CSF-45-120-GH** is confirmed from the above calculations.

Review the operation conditions and model number



Harmonic Planetary®

Harmonic Drive®

Technical Information

Efficiency 134

Output Bearing Specifications and 153
Checking Procedure

Input Bearing Specifications and 157
Checking Procedure

Product Handling

Assembly 159

Mechanical Tolerances 162

Lubrication 163

Warranty, Disposal 165

Safety 166

The rated value and performance vary depending on the product series.
Be sure to check the usage conditions and refer to the items conforming
to the related product.

Efficiency

In general, the efficiency of a speed reducer depends on the reduction ratio, input rotational speed, load torque, temperature and lubrication condition. The efficiency of each series under the following measurement conditions is plotted in the graphs on the next page. The values in the graph are average values.

Measurement condition

Table 134-1

| | |
|------------------------|---|
| Input rotational speed | HPGP / HPG / HPF / HPN: 3000rpm CSG-GH / CSF-GH: Indicated on each efficiency graph. |
| Ambient temperature | 25°C |
| Lubricant | Use standard lubricant for each model. (See pages 163- 164 for details.) |

Efficiency compensated for low temperature

Calculate the efficiency at an ambient temperature of 25°C or less by multiplying the efficiency at 25°C by the low-temperature efficiency correction value. Obtain values corresponding to an ambient temperature and to an input torque (TRi*) from the following graphs when calculating the low-temperature efficiency correction value.

HPGP

HPG

HPF

HPN

* TRi is an input torque corresponding to output torque at 25°C.

Graph 134-1

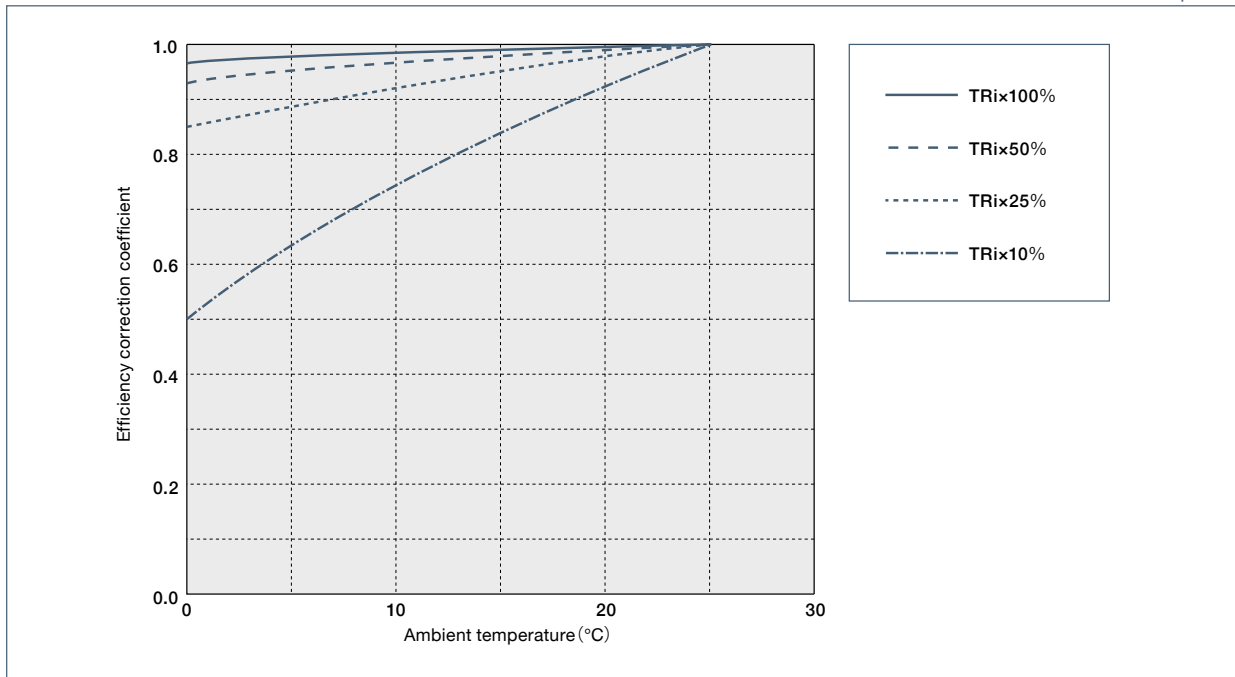

CSG-GH

CSF-GH

* TRi is an input torque corresponding to output torque at 25°C.

Graph 134-2

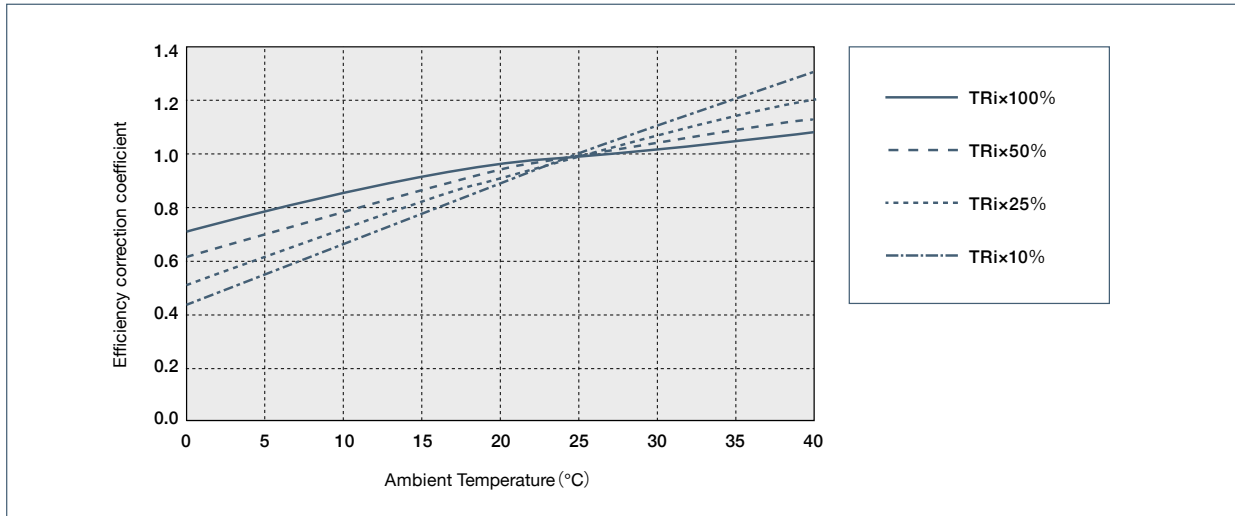

Size 11 : Gearhead

HPGP

Reduction Ratio = 5

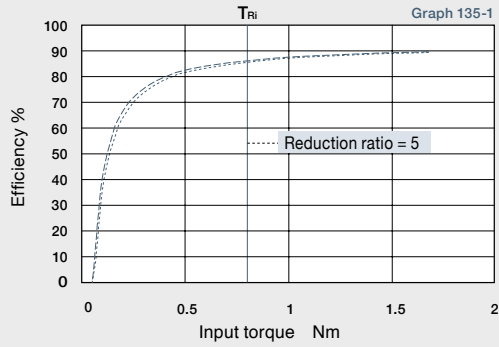

Reduction Ratio = 21

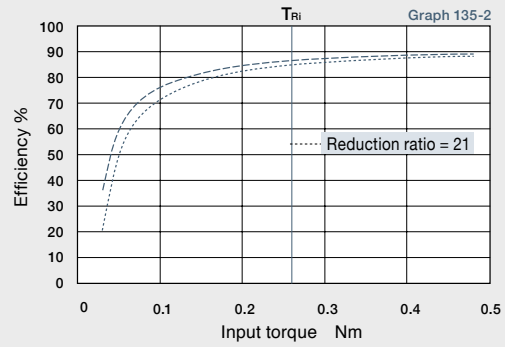

Reduction Ratio = 37, 45

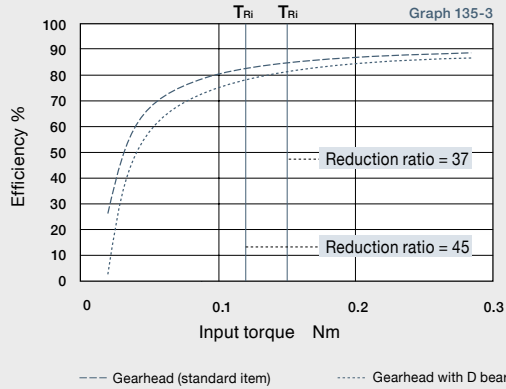

--- Gearhead (standard item) - - - - Gearhead with D bearing (double sealed) T_{Ri} Input torque corresponding to output torque

Size 14 : Gearhead

HPGP

Reduction Ratio = 5

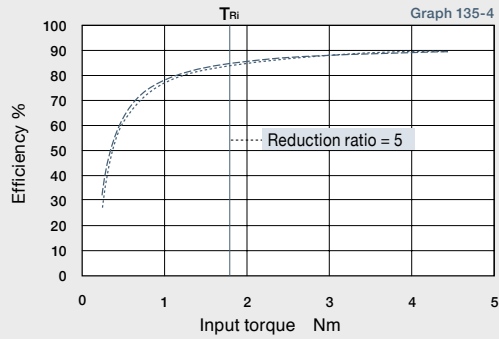

Reduction Ratio = 11

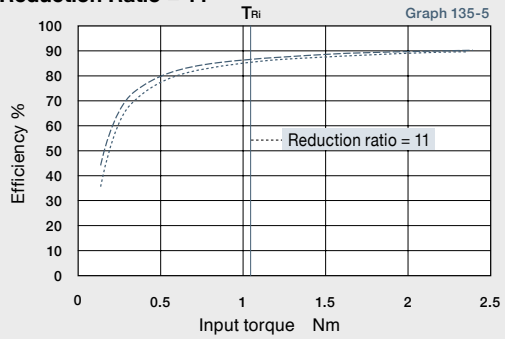

Reduction Ratio = 15, 21

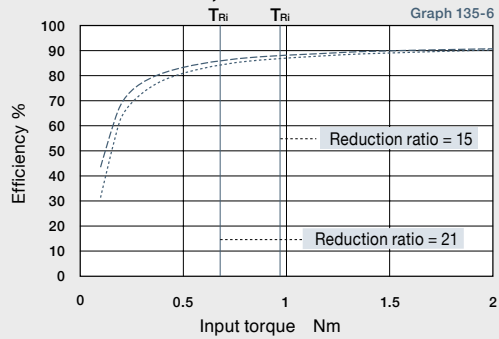

Reduction Ratio = 33, 45

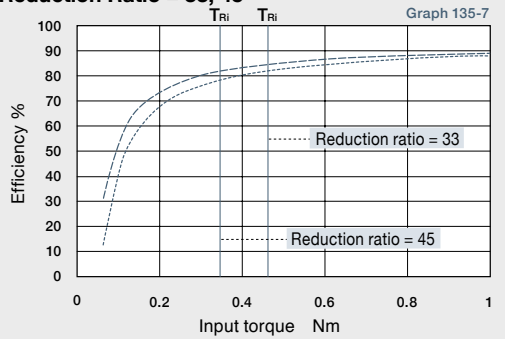

--- Gearhead (standard item) - - - - Gearhead with D bearing (double sealed) T_{Ri} Input torque corresponding to output torque

Size 20 : Gearhead

HPGP

Reduction ratio = 5

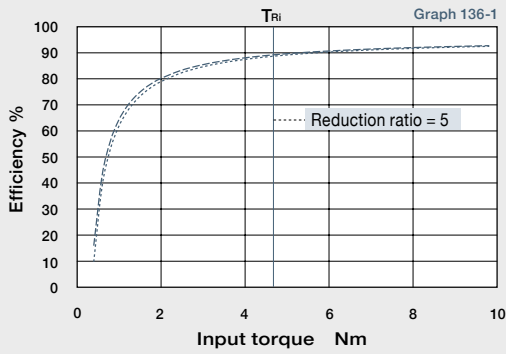

Reduction ratio = 11

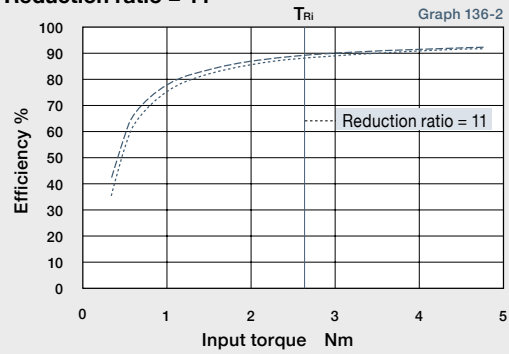

Reduction ratio = 15, 21

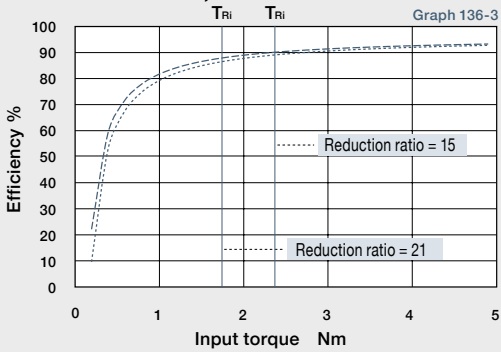

Reduction ratio = 33, 45

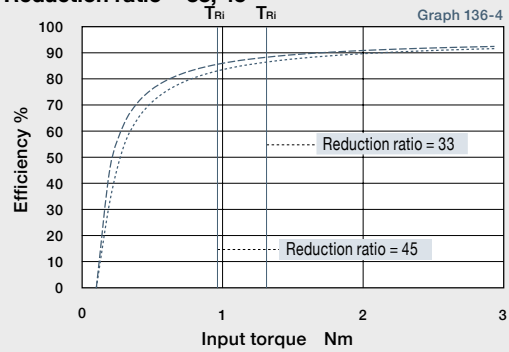

--- Gearhead (standard item)

----- Gearhead with D bearing (double sealed)

T_{Ri} Input torque corresponding to output torque

Size 32 : Gearhead

HPGP

Reduction ratio = 5 *1

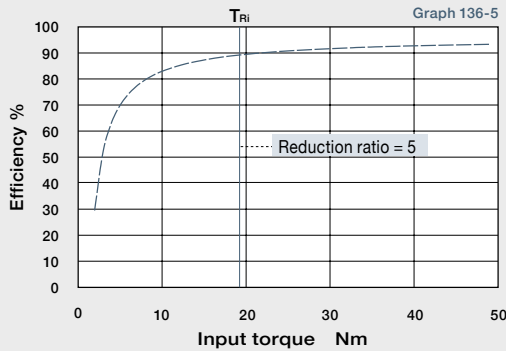

Reduction ratio = 11

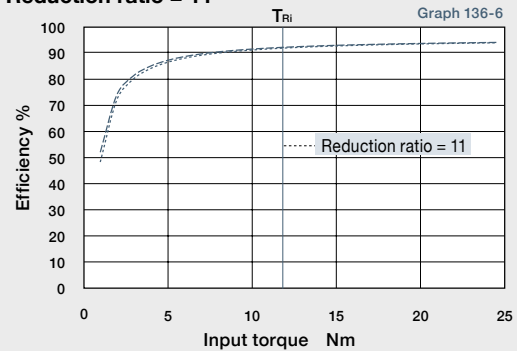

Reduction ratio = 15, 21

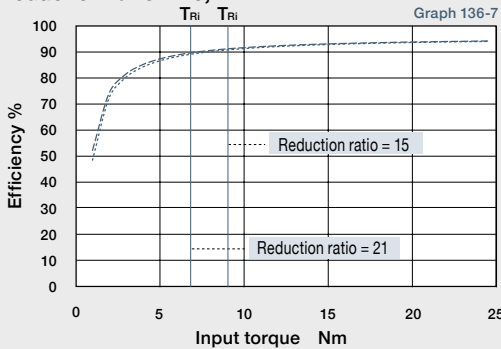

Reduction ratio = 33, 45

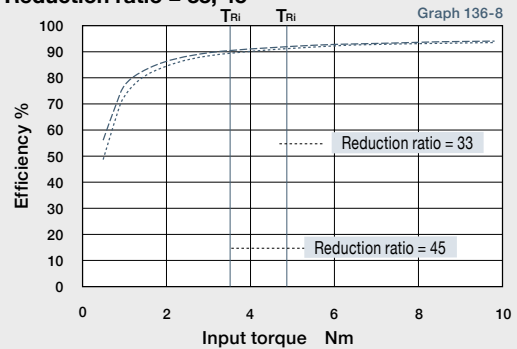

--- Gearhead (standard item)

----- Gearhead with D bearing (double sealed)

T_{Ri} Input torque corresponding to output torque

*1 Only one line is shown because the difference between the gearhead and a bearing assembled on the input side is small.

Size 50 : Gearhead

HPGP

Reduction ratio = 5 *2

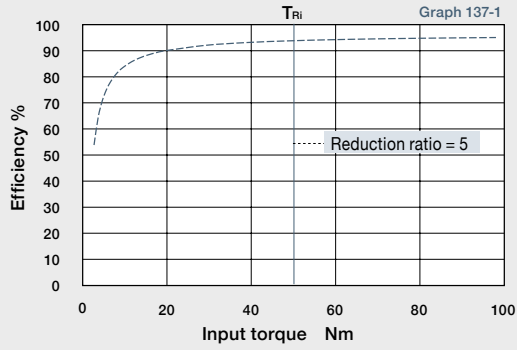

Reduction ratio = 11 *2

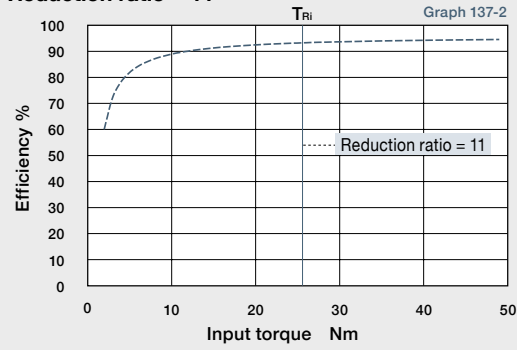

Reduction ratio = 15, 21 *2

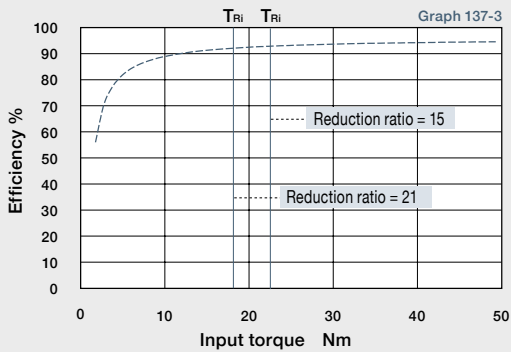

Reduction ratio = 33, 45

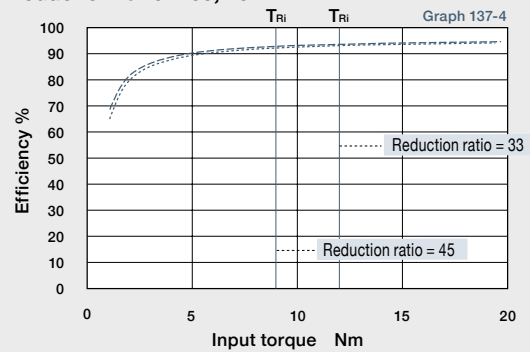

--- Gearhead (standard item)

----- Gearhead with D bearing (double sealed)

T_{Ri} Input torque corresponding to output torque

*2 Only one line is shown because the difference between the gearhead and a bearing assembled on the input side is small.

Size 65 : Gearhead

HPGP

Reduction ratio = 4, 5 *3

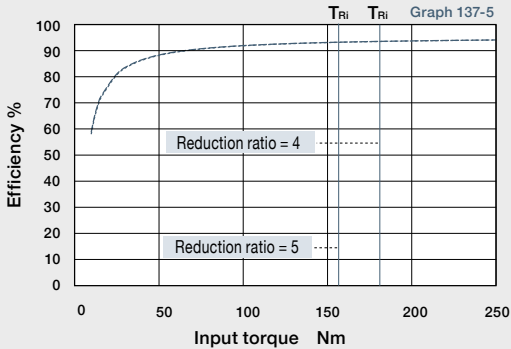

Reduction ratio = 12 *3

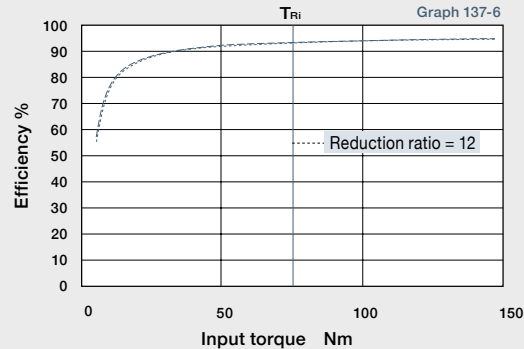

Reduction ratio = 15, 20 *3

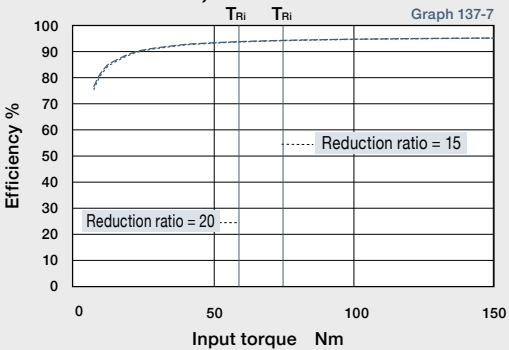

Reduction ratio = 25 *3

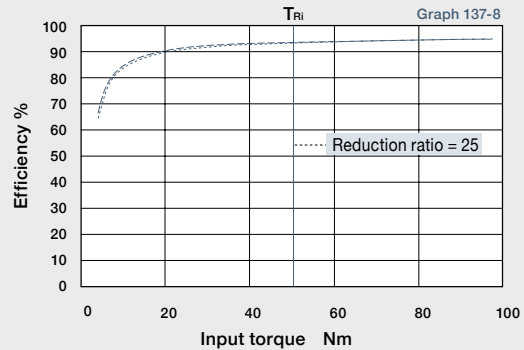

--- Gearhead (standard item)

----- Gearhead with D bearing (double sealed)

T_{Ri} Input torque corresponding to output torque

*3 Only one line is shown because the difference between the gearhead and a bearing assembled on the input side is small.

Size 11 : Gearhead & Input Shaft Unit

HPG

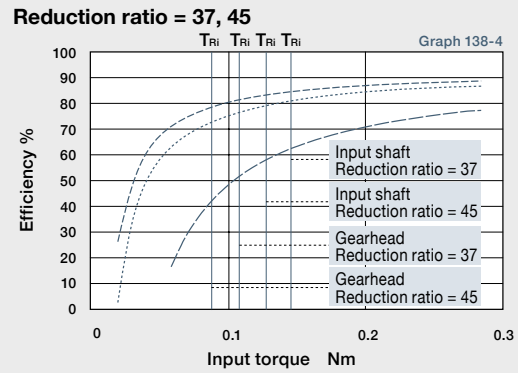
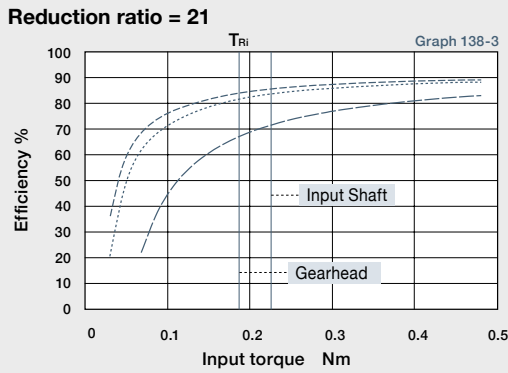
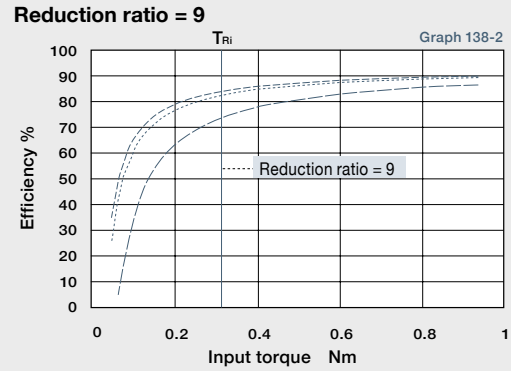
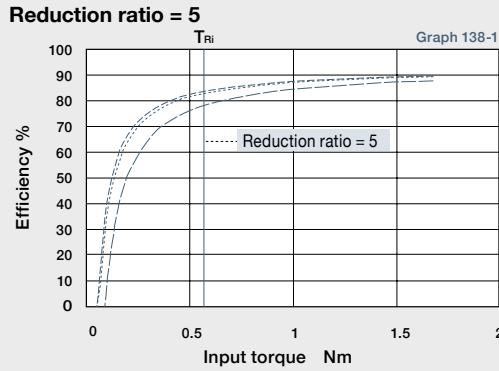

--- Gearhead (standard item)

..... Gearhead with D bearing (double sealed)

T_{Ri} Input torque corresponding to output torque

Size 14 : Gearhead & Input Shaft Unit

HPG

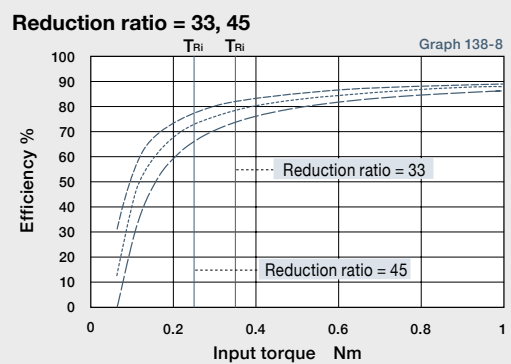
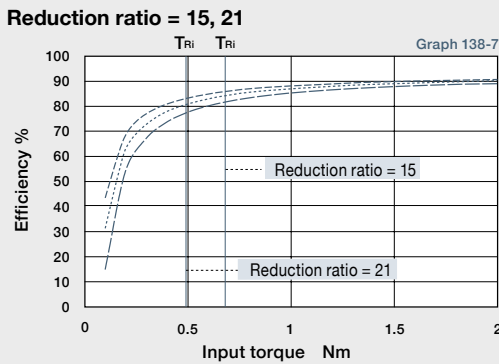
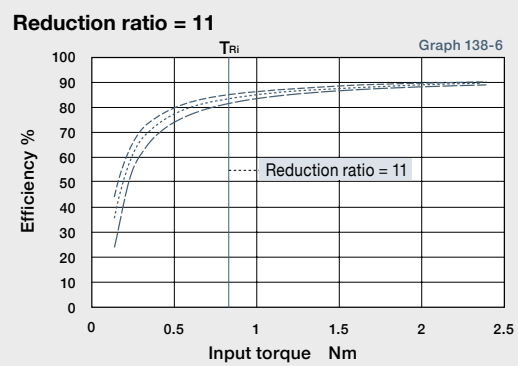
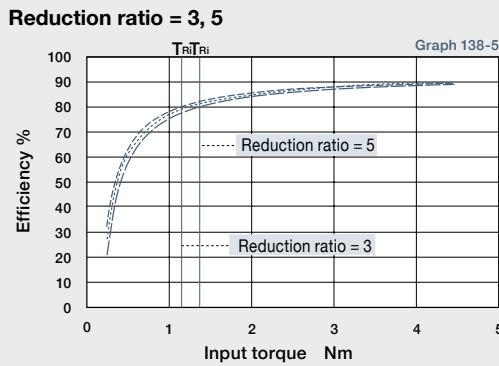

--- Gearhead (standard item)

..... Gearhead with D bearing (double sealed)

T_{Ri} Input torque corresponding to output torque

Size 20 : Gearhead & Input Shaft Unit

HPG

Reduction ratio = 3, 5

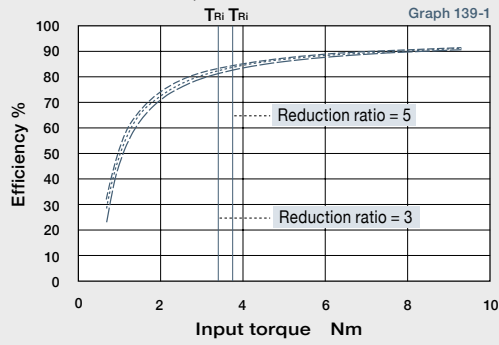

Reduction ratio = 11

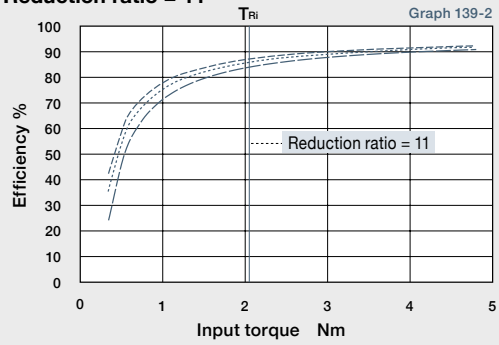

Reduction ratio = 15, 21

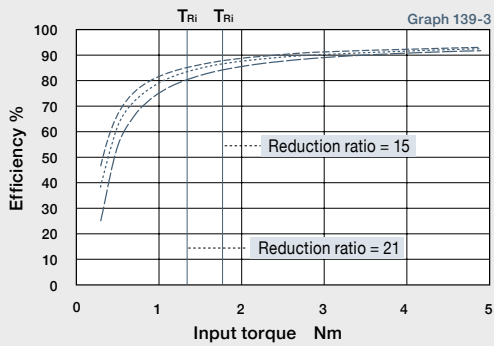

Reduction ratio = 33, 45

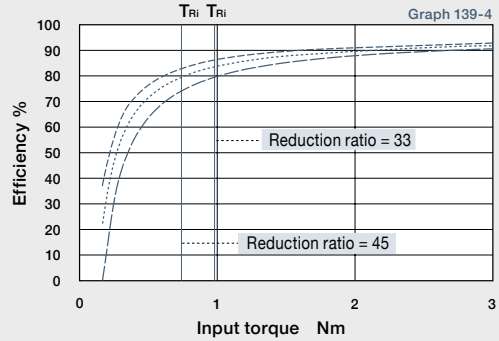

--- Gearhead (standard item) - - - - Gearhead with D bearing (double sealed) — Input Shaft T_{Ri} Input torque corresponding to output torque

Size 32 : Gearhead & Input Shaft Unit

HPG

Reduction ratio = 3, 5*1

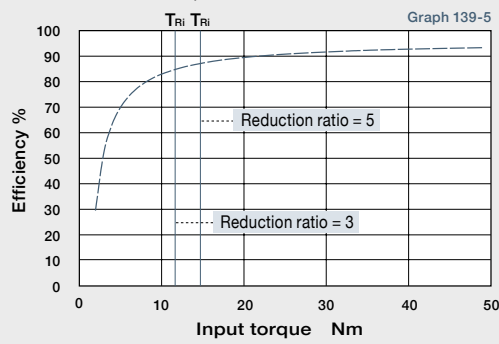

Reduction ratio = 11

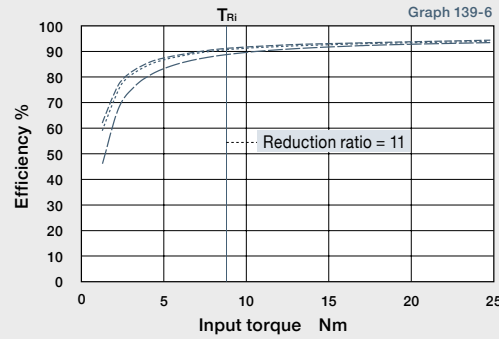

Reduction ratio = 15, 21

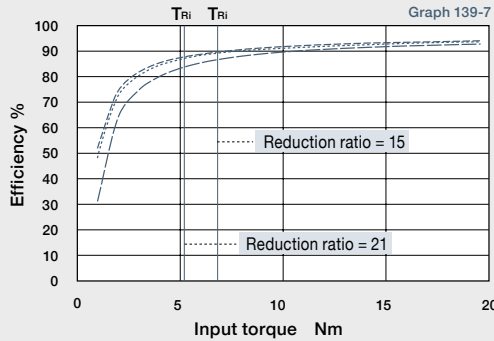

Reduction ratio = 33, 45

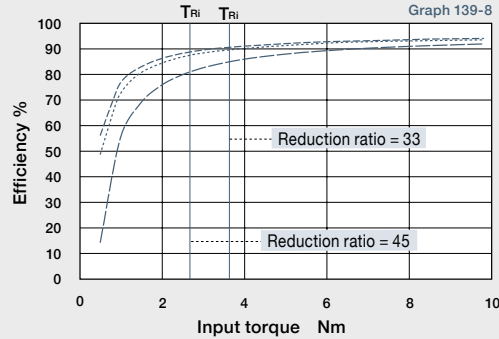

--- Gearhead (standard item) - - - - Gearhead with D bearing (double sealed) — Input Shaft T_{Ri} Input torque corresponding to output torque

*1 Only one line is shown because the difference between the gearhead and a bearing assembled on the input side is small.

Size 50 : Gearhead & Input Shaft Unit

HPG

Reduction ratio = 3, 5*2

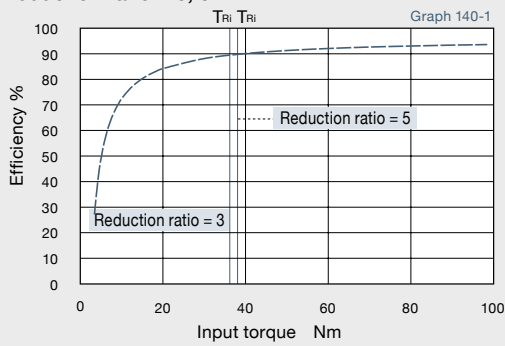

Reduction ratio = 11*2

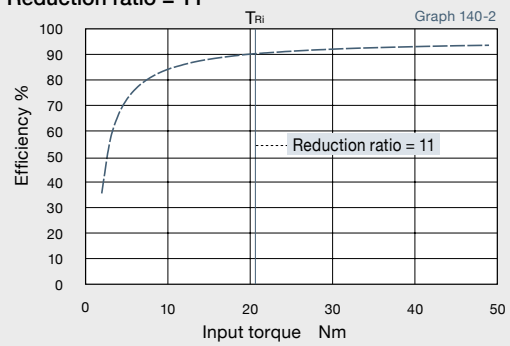

Reduction ratio = 15, 21*2

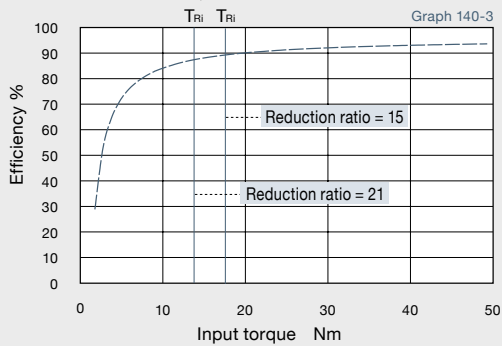

Reduction ratio = 33, 45

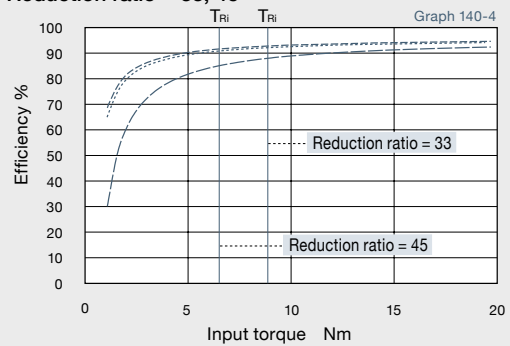

--- Gearhead (standard item) - - - - Gearhead with D bearing (double sealed) — Input Shaft T_{Ri} Input torque corresponding to output torque

*2 Only one line is shown because the difference between the gearhead and a bearing assembled on the input side is small.

Size 65 : Gearhead & Input Shaft Unit

HPG

Reduction ratio = 4, 5*3

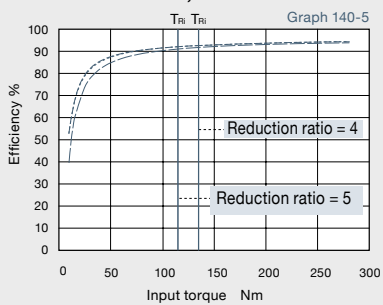

Reduction ratio = 12

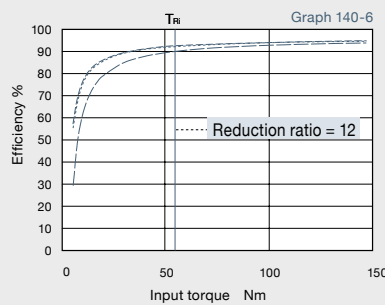

Reduction ratio = 15, 20

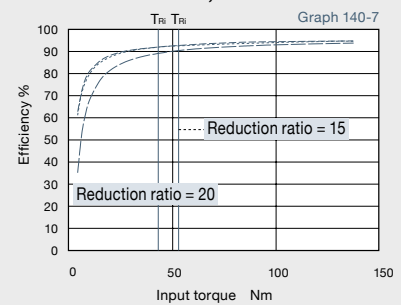

Reduction ratio = 25

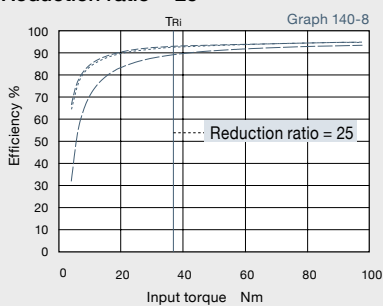

Reduction ratio = 40*3

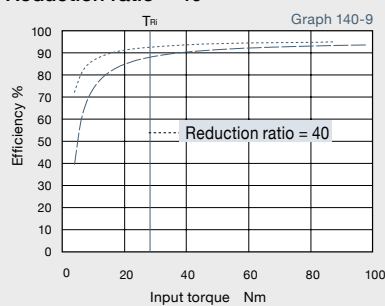

Reduction ratio = 50

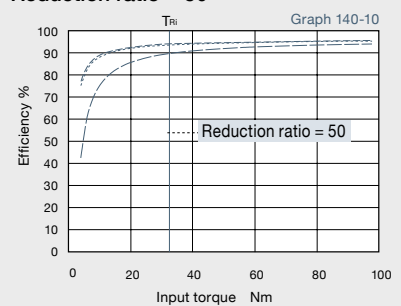

--- Gearhead (standard item) - - - - Gearhead with D bearing (double sealed) — Input Shaft T_{Ri} Input torque corresponding to output torque

*3 Only one line is shown because the difference between the gearhead and a bearing assembled on the input side is small.

Size 11

: Gearhead

HPG-Helical

Reduction ratio = 4

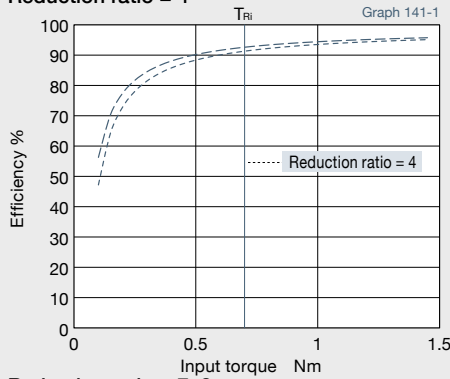

Reduction ratio = 5, 6

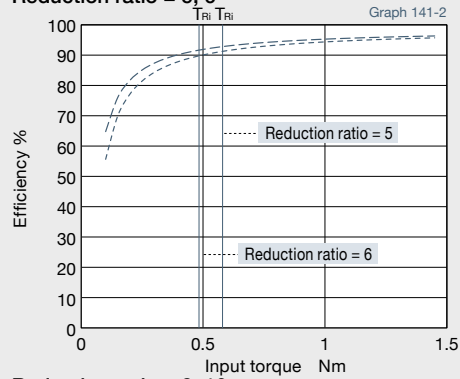

Reduction ratio = 7, 8

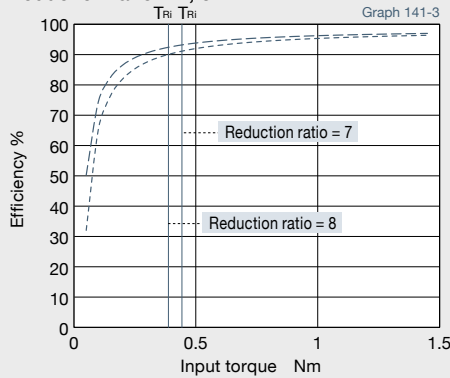

Reduction ratio = 9, 10

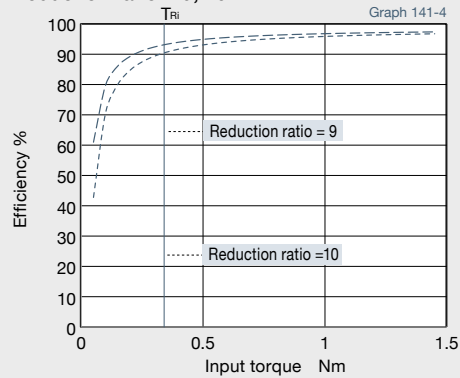

--- Gearhead with Z bearing (Double shielded)

..... Gearhead with D bearing (double sealed)

T_{Ri} Input torque corresponding to output torque

Size 14

: Gearhead

HPG-Helical

Reduction ratio = 3, 4

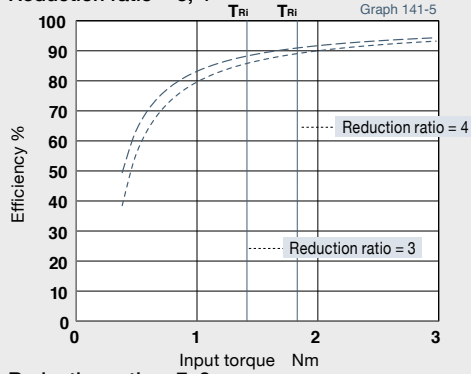

Reduction ratio = 5, 6

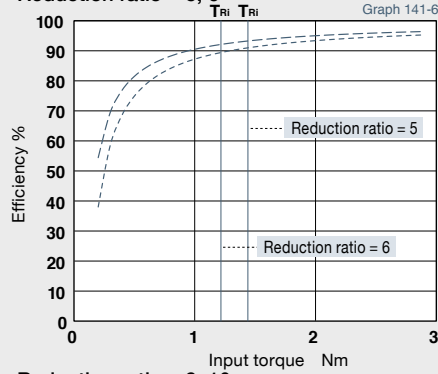

Reduction ratio = 7, 8

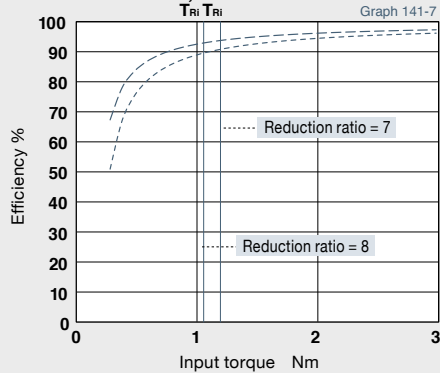

Reduction ratio = 9, 10

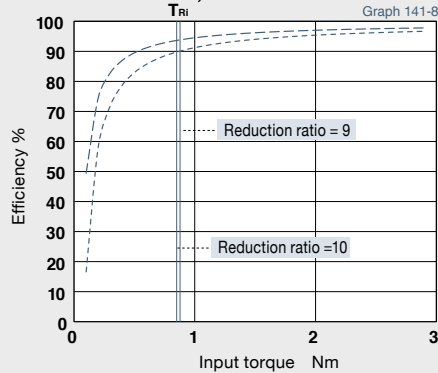

--- Gearhead with Z bearing (Double shielded)

..... Gearhead with D bearing (double sealed)

T_{Ri} Input torque corresponding to output torque

Size 20 : Gearhead

HPG-Helical

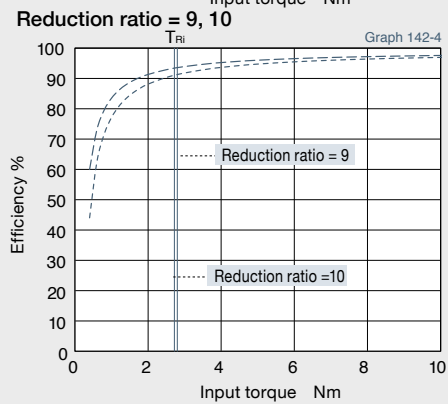
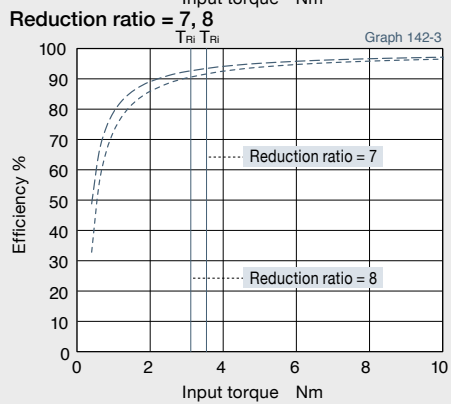
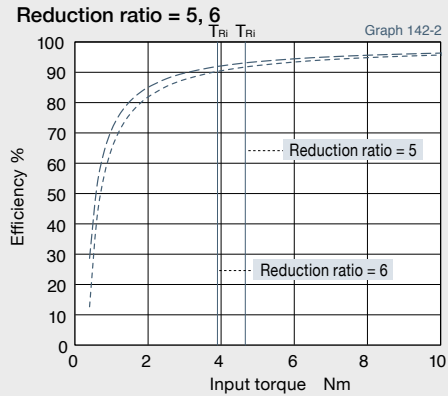
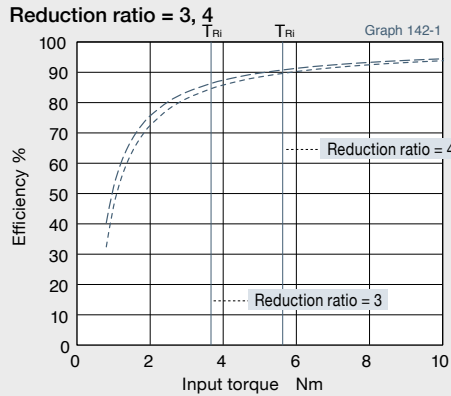

--- Gearhead with Z bearing (Double shielded) - - - - - Gearhead with D bearing (double sealed) T_{Ri} Input torque corresponding to output torque

Size 32 : Gearhead

HPG-Helical

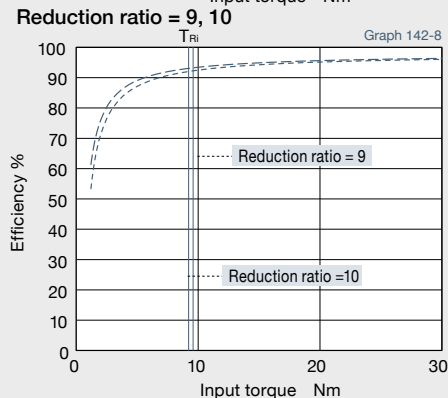
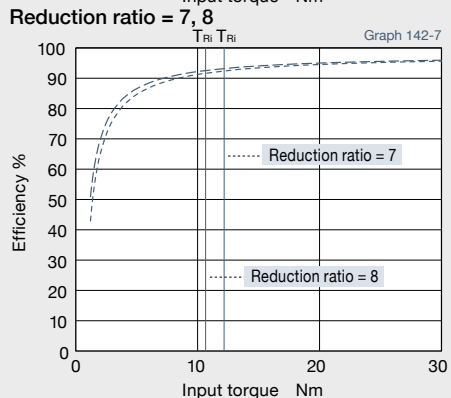
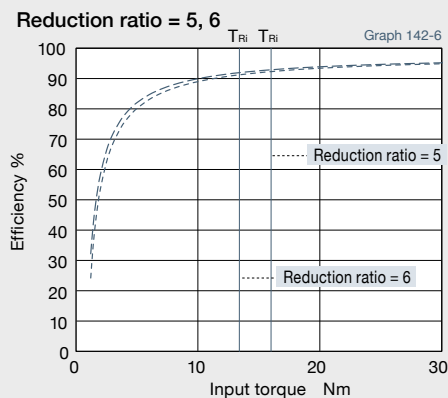
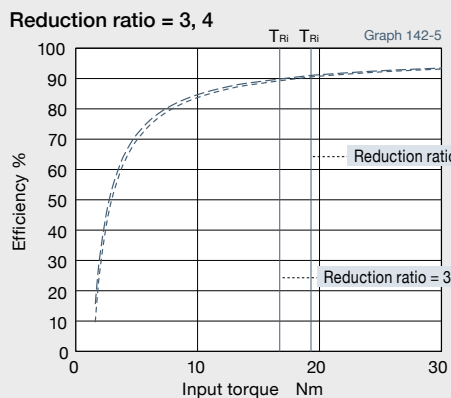

--- Gearhead with Z bearing (Double shielded) - - - - - Gearhead with D bearing (double sealed) T_{Ri} Input torque corresponding to output torque

Size 32 RA3 : Right Angle Gearhead

HPG

Reduction ratio = 5

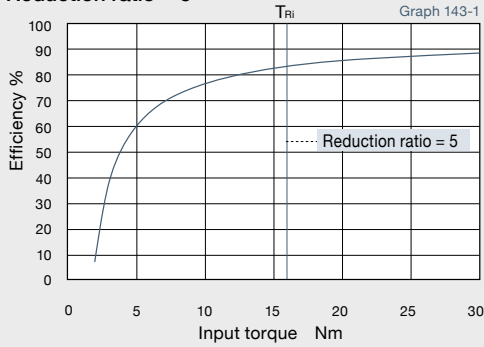

Reduction ratio = 11

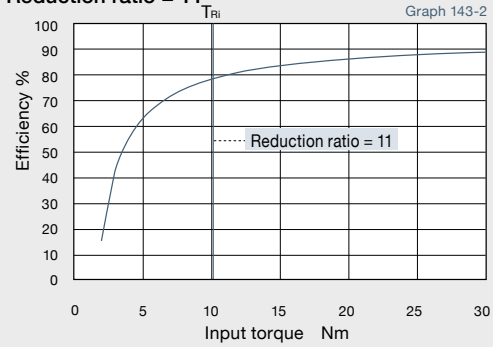

Reduction ratio = 15, 21

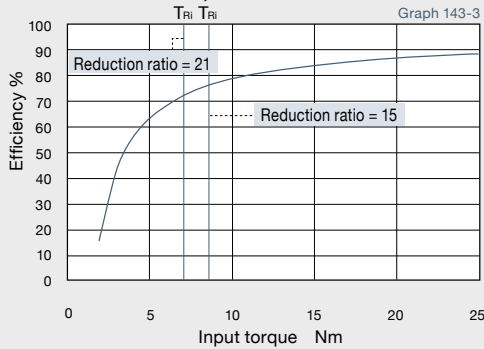

Reduction ratio = 33, 45

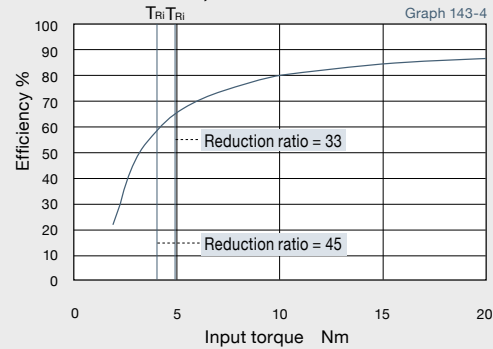

T_{Ri} Input torque corresponding to output torque

Size 50 RA3 : Right Angle Gearhead

HPG

Reduction ratio = 5

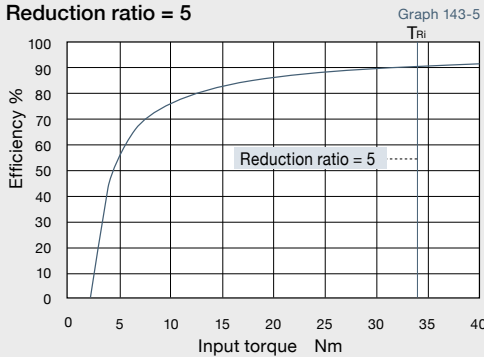

Reduction ratio = 11

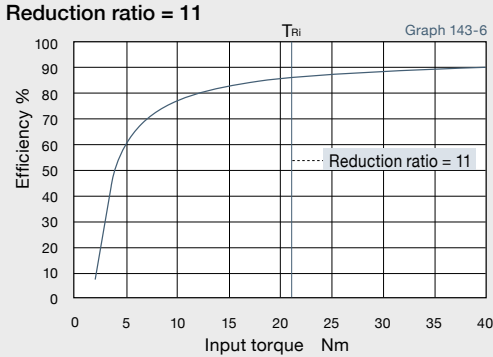

Reduction ratio = 15, 21

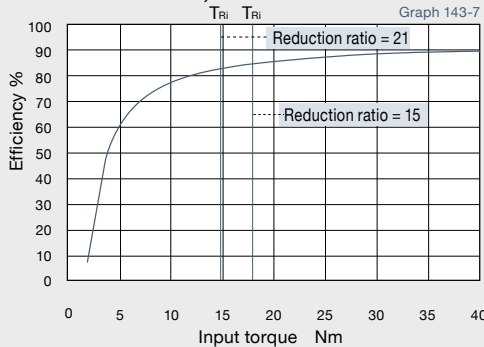

Reduction ratio = 33, 45

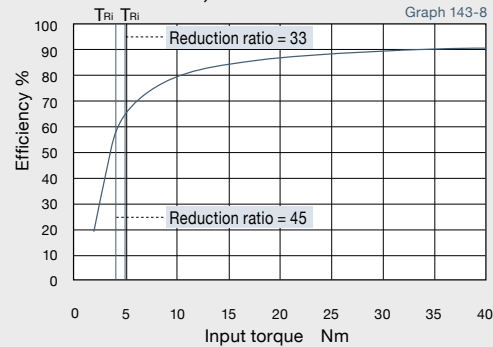

T_{Ri} Input torque corresponding to output torque

Size 50 RA5 : Right Angle Gearhead

HPG

Reduction ratio = 5

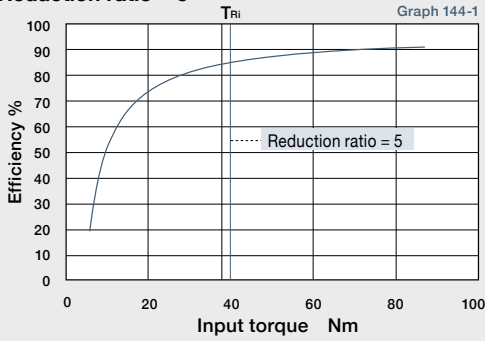

Reduction ratio = 11

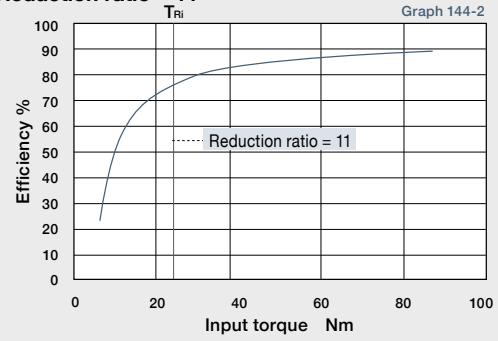

Reduction ratio = 15, 21

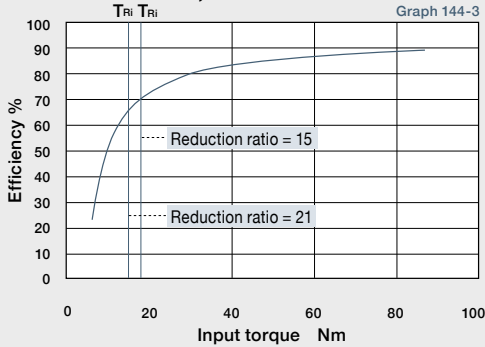

Reduction ratio = 33, 45

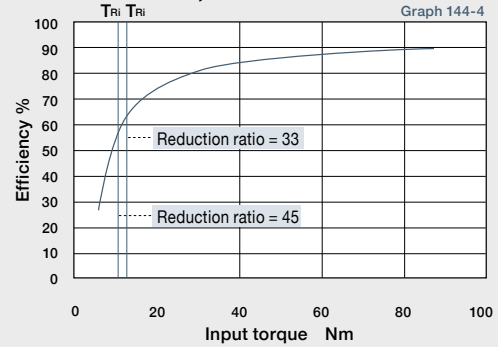

T_{Ri} Input torque corresponding to output torque

Size 65 RA5 : Right Angle Gearhead

HPG

Reduction ratio = 5

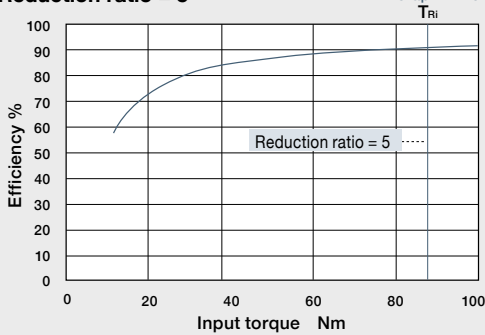

Reduction ratio = 12, 15

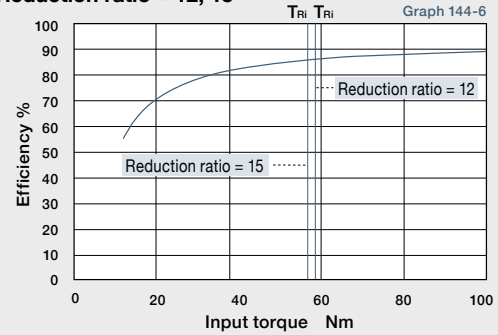

Reduction ratio = 20, 25

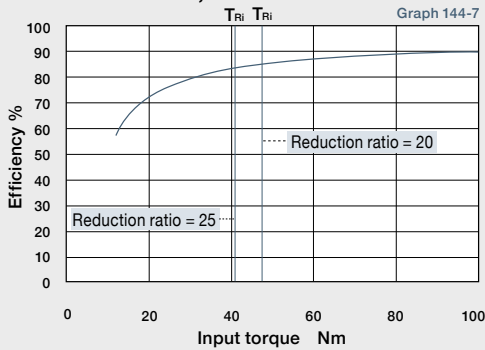

Reduction ratio = 40, 50

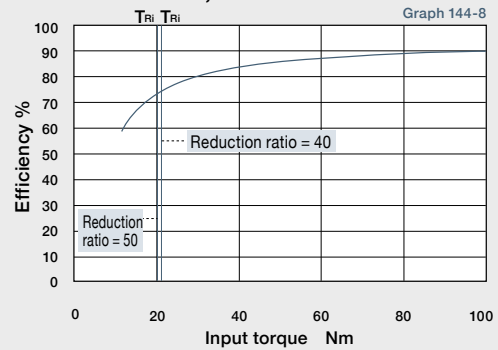

T_{Ri} Input torque corresponding to output torque

Size 11

HPN

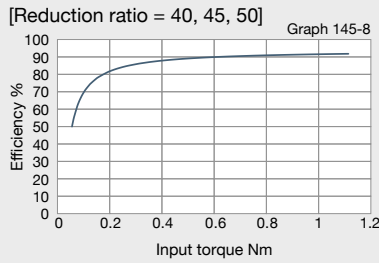
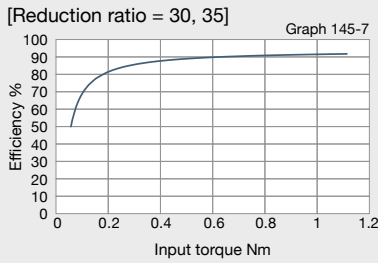
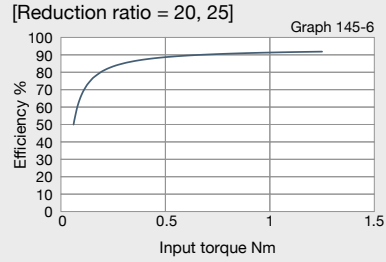
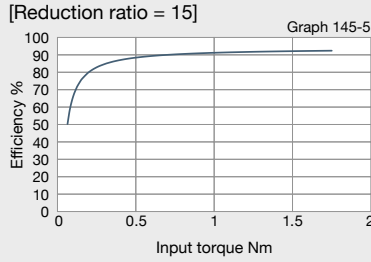
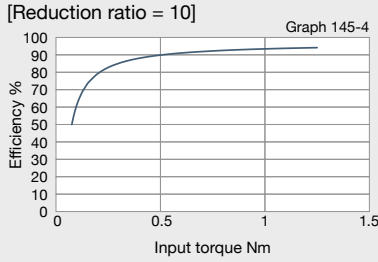
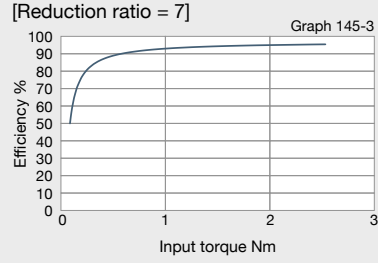
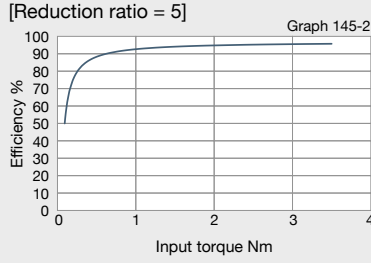
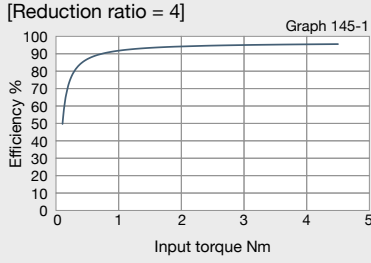

Size 14

HPN

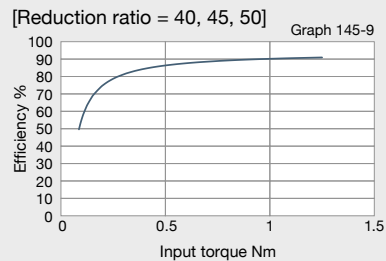
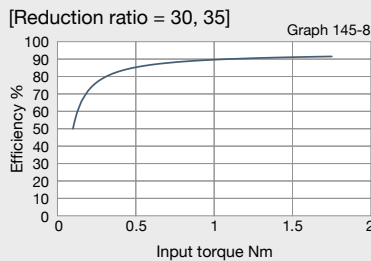
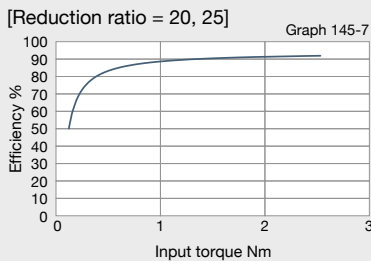
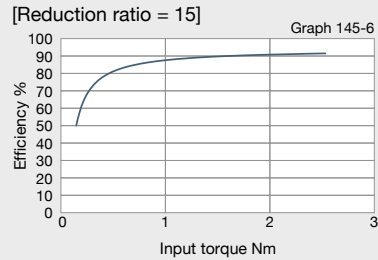
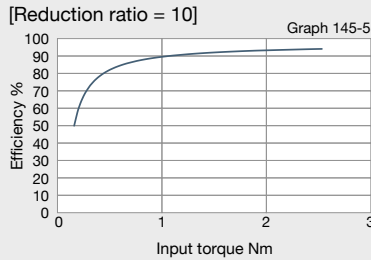
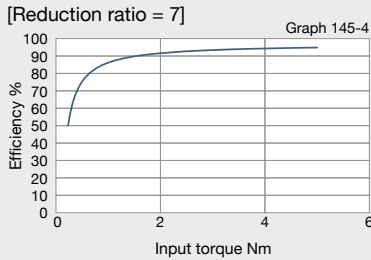
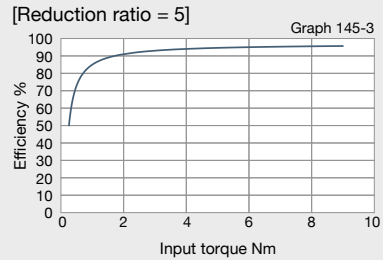
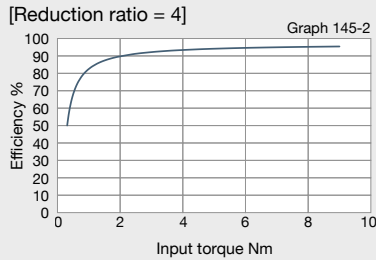
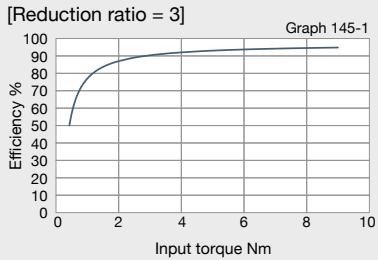

Size 20

HPN

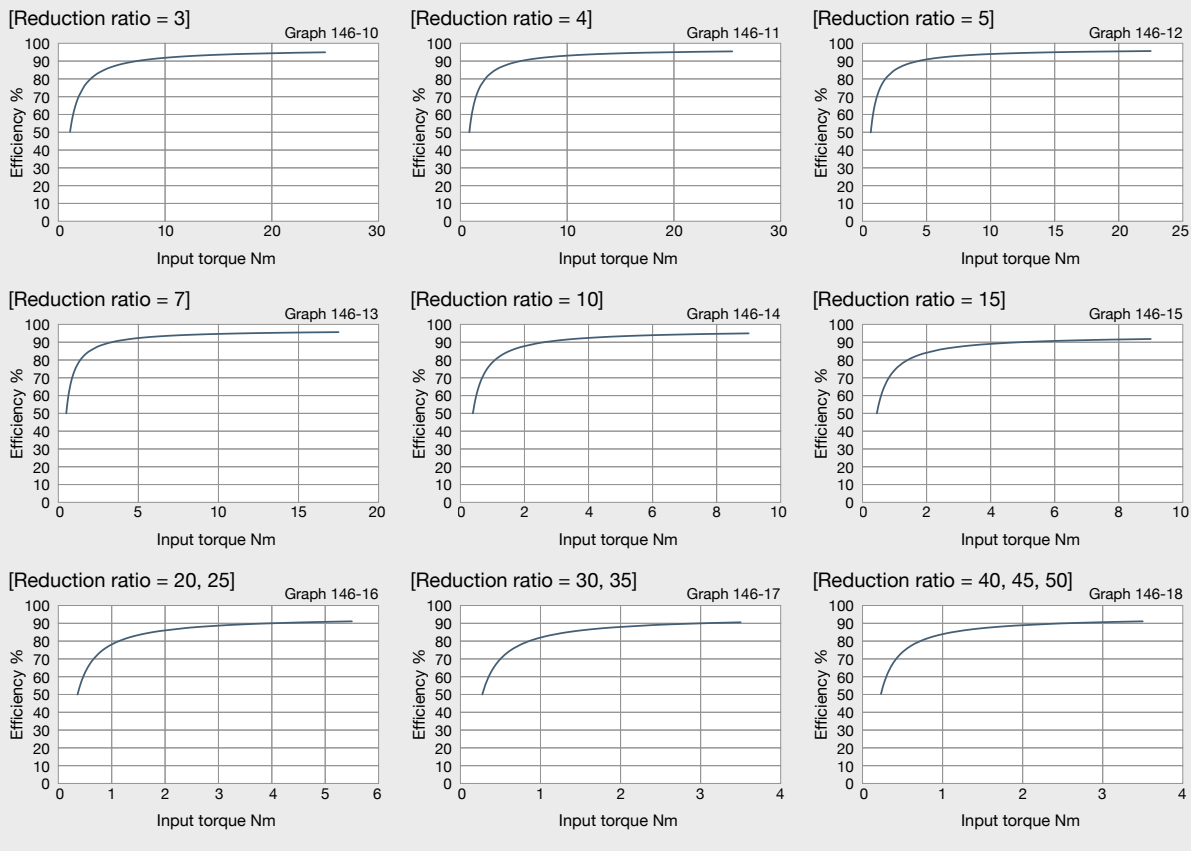

Size 32

HPN

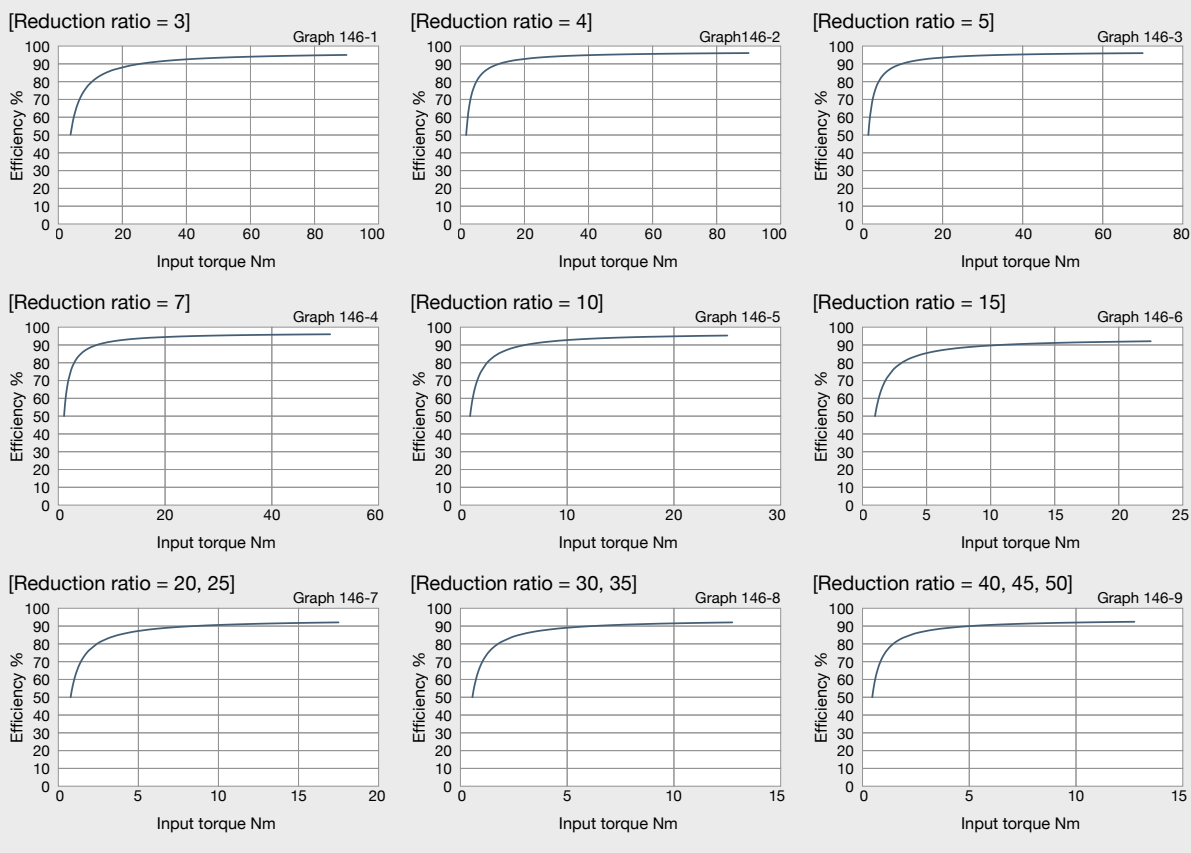

Size 40

HPN

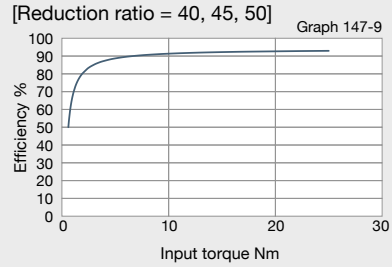
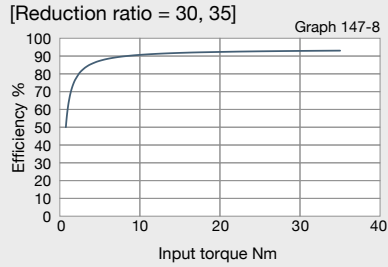
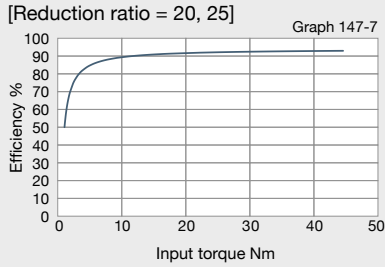
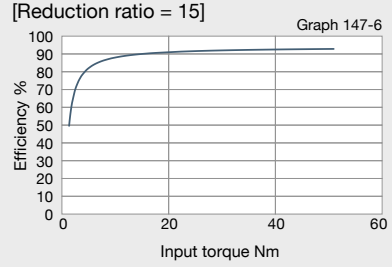
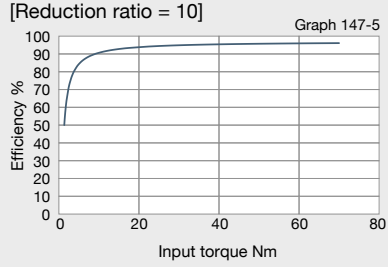
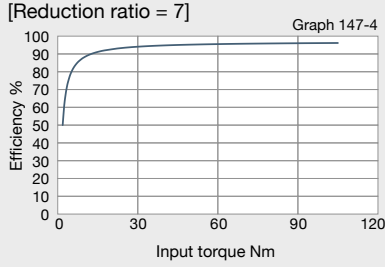
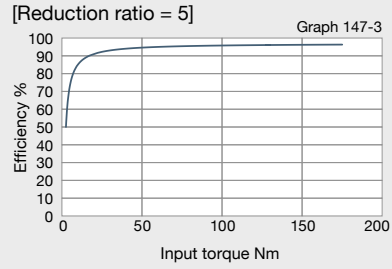
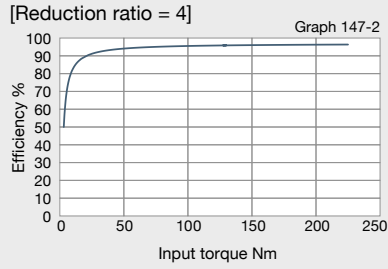
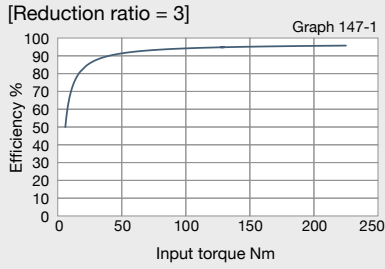

Size 25 : Hollow Shaft Unit

HPF

Reduction ratio = 11

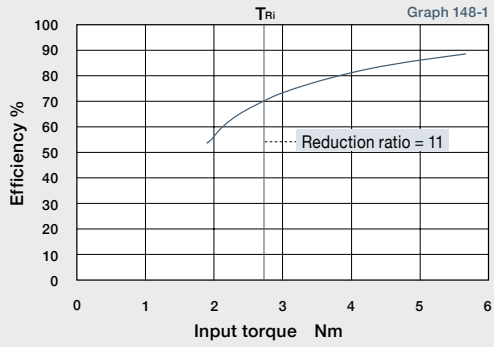

Size 32 : Hollow Shaft Unit

HPF

Reduction ratio = 11

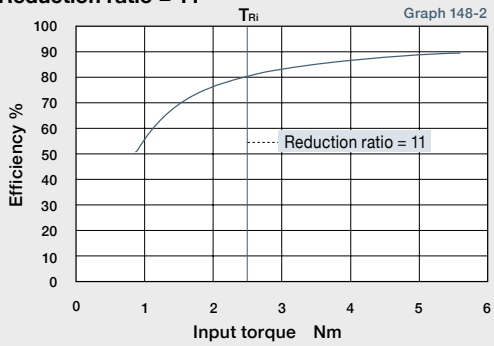

Size 14 : Gearhead

CSG-GH

CSF-GH

Reduction ratio = 50

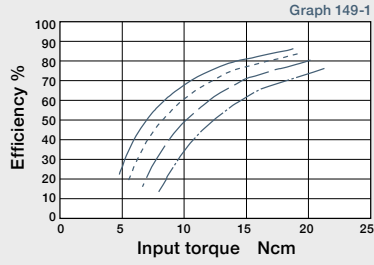

Reduction ratio = 80

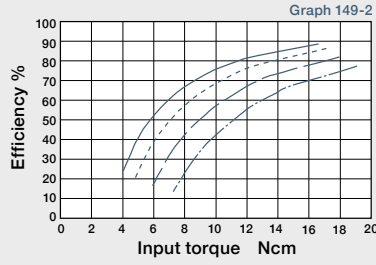

Reduction ratio = 100

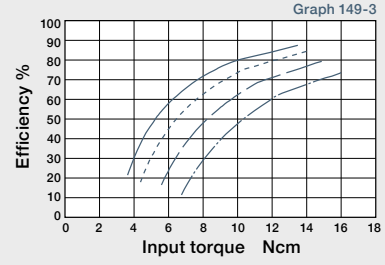

Input rotational speed — 500 rpm - - - - - 1000 rpm - · - · - 2000 rpm · · · · · 3500 rpm

Size 20 : Gearhead

CSG-GH

CSF-GH

Reduction ratio = 50

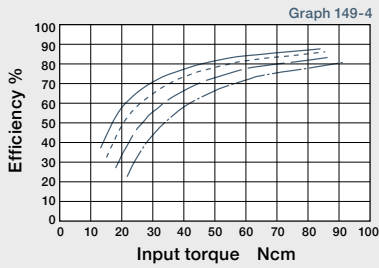

Reduction ratio = 80

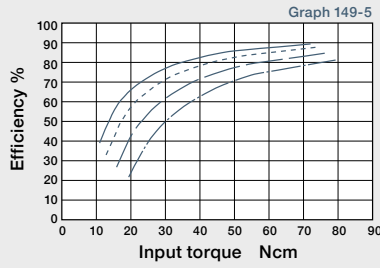

Reduction ratio = 100

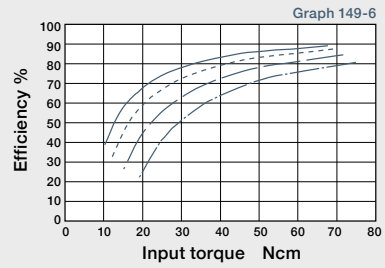

Reduction ratio = 120

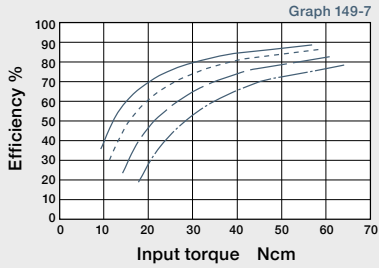

Reduction ratio = 160

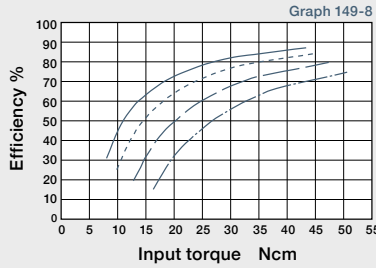

Input rotational speed — 500 rpm - - - - - 1000 rpm - · - · - 2000 rpm · · · · · 3500 rpm

Size 32 : Gearhead

CSG-GH

CSF-GH

Reduction ratio = 50

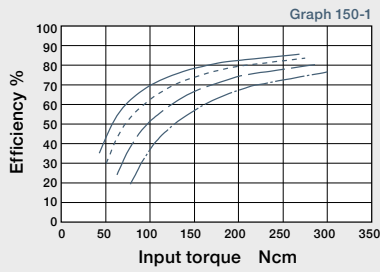

Reduction ratio = 80

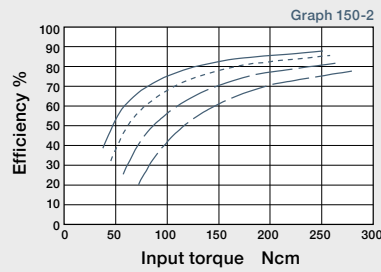

Reduction ratio = 100

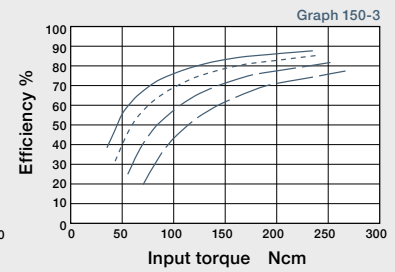

Reduction ratio = 120

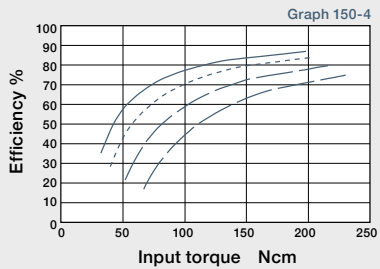

Reduction ratio = 160

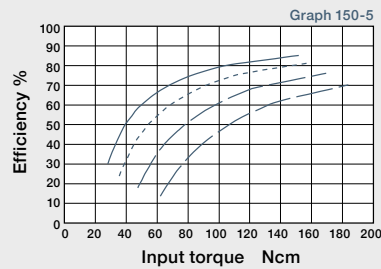

Input rotational speed — 500 rpm — 1000 rpm — 2000 rpm — 3500 rpm

Size 45 : Gearhead

CSG-GH

CSF-GH

Reduction ratio = 50

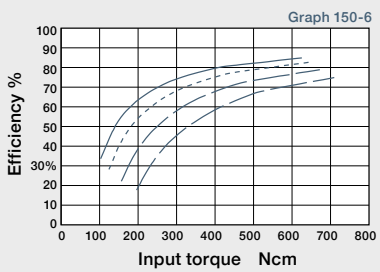

Reduction ratio = 80

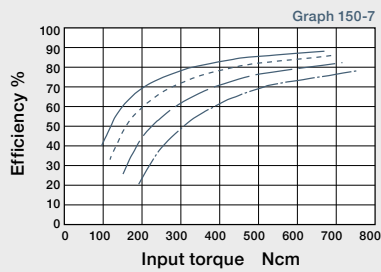

Reduction ratio = 100

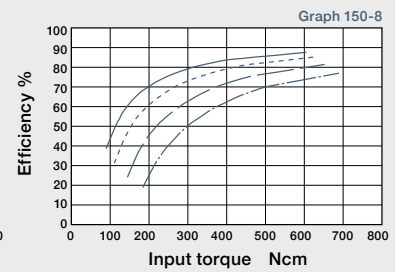

Reduction ratio = 120

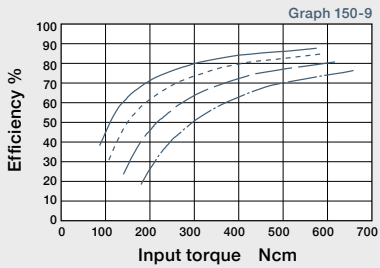

Reduction ratio = 160

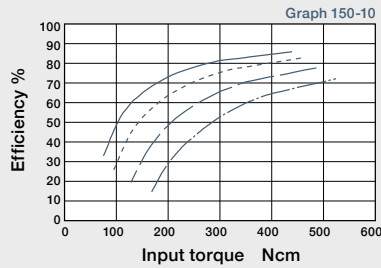

Input rotational speed — 500 rpm — 1000 rpm — 2000 rpm — 3500 rpm

Size 65

: Gearhead

CSG-GH

CSF-GH

Reduction ratio = 80

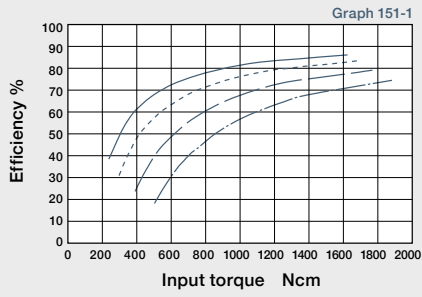

Reduction ratio = 100

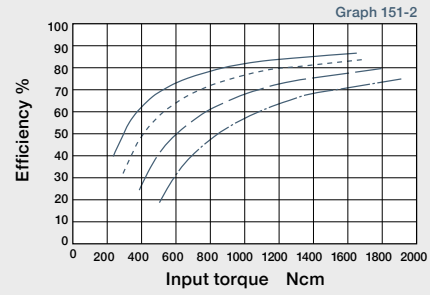

Reduction ratio = 120

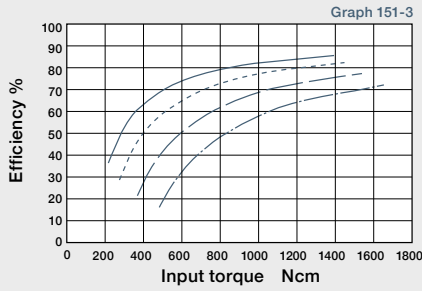

Reduction ratio = 160

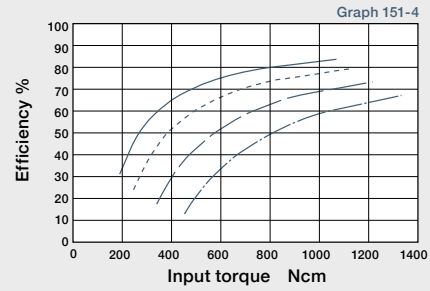

Input rotational speed — 500 rpm - - - - - 1000 rpm — 2000 rpm — 3500 rpm

Output Shaft Bearing Load Limits

HPN Series Output Shaft Load Limits are plotted below.

HPN uses deep groove ball bearings to support the output shaft. Please use the curve on the graph for the appropriate load coefficient (f_w) that represents the expected operating condition.

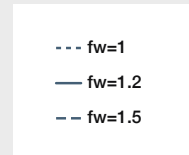
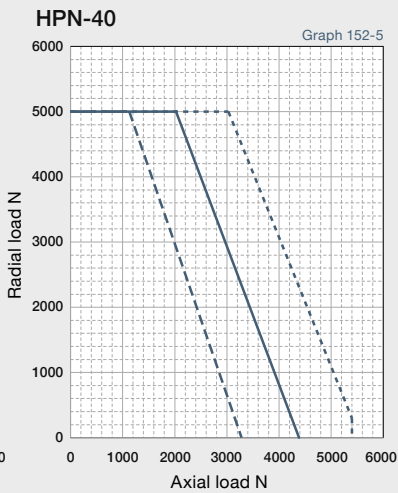
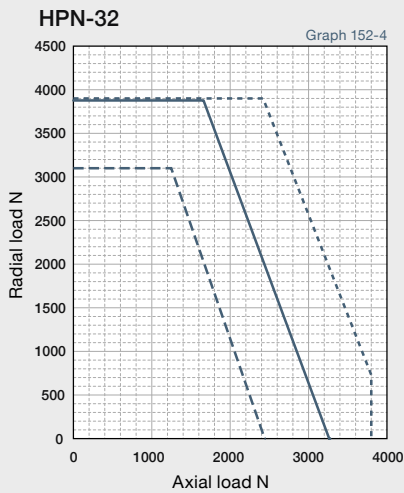
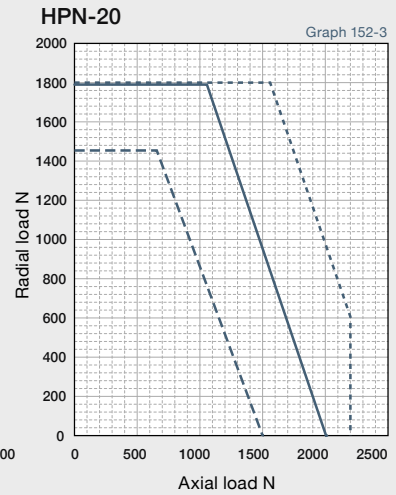
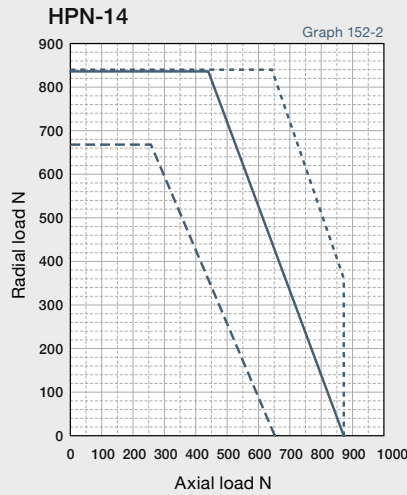
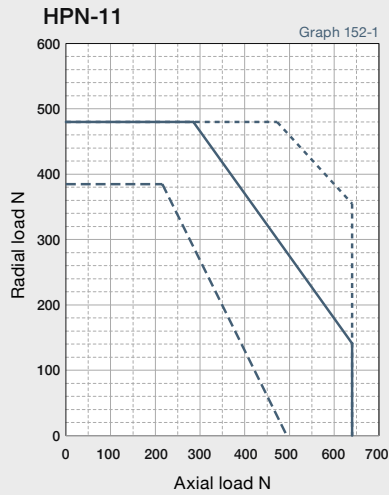

Load coefficient
 $f_w=1-1.2$ Smooth operation
 without impact
 $f_w=1.2-1.5$ Standard operation

Output shaft speed - 100 rpm, bearing life is based on 20,000 hours. The load-point is based on shaft center of radial load and axial load.

Output Bearing Specifications and Checking Procedure

HPGP, HPG, HPG Helical, CSF-GH, CSG-GH, HPF, and HPG-U1 are equipped with cross roller bearings. A precision cross roller bearing supports the external load (output flange). Check the maximum load, moment load, life of the bearing and static safety coefficient to maximize performance.

Checking procedure

(1) Checking the maximum moment load (M max)

Calculate the maximum moment load (M max). ●●▶ Maximum moment load (M max) ≤ Permissible moment (Mc)

(2) Checking the life

Calculate the average radial load (F_{rav}) and the average axial load (F_{axv}). ●●▶ Calculate the radial load coefficient (X) and the axial load coefficient (Y). ●●▶ Calculate the life and check it.

(3) Checking the static safety coefficient

Calculate the static equivalent radial load coefficient (P₀). ●●▶ Check the static safety coefficient. (f_s)

Specification of output bearing

HPGP/HPG Series Tables 153-1, -2 and -3 indicate the cross roller bearing specifications for in-line, right angle and input shaft gears.

Table 153-1

| Size | Pitch circle | Offset amount | Basic rated load | | | | Allowable moment load Mc ^{*3} | | Moment stiffness Km ^{*4} | |
|------|--------------|---------------|---|------|---|-------|--|-------|-----------------------------------|-------------------|
| | dp | R | Basic dynamic load rating C ^{*1} | | Basic static load rating Co ^{*2} | | Nm | Kgf·m | x10 ⁴ Nm/rad | Kgf·m/ arc min |
| | m | m | N | kgf | N | kgf | | | | |
| 11 | 0.0275 | 0.006 | 3116 | 318 | 4087 | 417 | 9.50 | 0.97 | 0.88 | 0.26 |
| 14 | 0.0405 | 0.011 | 5110 | 521 | 7060 | 720 | 32.3 | 3.30 | 3.0 | 0.90 |
| 20 | 0.064 | 0.0115 | 10600 | 1082 | 17300 | 1765 | 183 | 18.7 | 16.8 | 5.0 |
| 32 | 0.085 | 0.014 | 20500 | 2092 | 32800 | 3347 | 452 | 46.1 | 42.1 | 12.5 |
| 50 | 0.123 | 0.019 | 41600 | 4245 | 76000 | 7755 | 1076 | 110 | 100 | 29.7 |
| 65 | 0.170 | 0.023 | 90600 | 9245 | 148000 | 15102 | 3900 | 398 | 364 | 108 |

Table 153-2

| Size | Reduction ratio | Allowable radial load ^{*5} | Allowable axial load ^{*5} |
|------|-----------------|-------------------------------------|------------------------------------|
| | | N | N |
| 11 | 5 | 280 | 430 |
| | (9) | 340 | 510 |
| | 21 | 440 | 660 |
| | 37 | 520 | 780 |
| | 45 | 550 | 830 |
| 14 | (3) | 400 | 600 |
| | 5 | 470 | 700 |
| | 11 | 600 | 890 |
| | 15 | 650 | 980 |
| | 21 | 720 | 1080 |
| | 33 | 830 | 1240 |
| 20 | 45 | 910 | 1360 |
| | (3) | 840 | 1250 |
| | 5 | 980 | 1460 |
| | 11 | 1240 | 1850 |
| | 15 | 1360 | 2030 |
| | 21 | 1510 | 2250 |
| | 33 | 1729 | 2580 |
| 45 | 1890 | 2830 | |

* The ratio specified in parentheses is for the HPG Series.

Table 153-3

| Size | Reduction ratio | Allowable radial load ^{*5} | Allowable axial load ^{*5} |
|------|-----------------|-------------------------------------|------------------------------------|
| | | N | N |
| 32 | (3) | 1630 | 2430 |
| | 5 | 1900 | 2830 |
| | 11 | 2410 | 3590 |
| | 15 | 2640 | 3940 |
| | 21 | 2920 | 4360 |
| | 33 | 3340 | 4990 |
| | 45 | 3670 | 5480 |
| 50 | (3) | 3700 | 5570 |
| | 5 | 4350 | 6490 |
| | 11 | 5500 | 8220 |
| | 15 | 6050 | 9030 |
| | 21 | 6690 | 9980 |
| | 33 | 7660 | 11400 |
| | 45 | 8400 | 12500 |
| 65 | 4 | 8860 | 13200 |
| | 5 | 9470 | 14100 |
| | 12 | 12300 | 18300 |
| | 15 | 13100 | 19600 |
| | 20 | 14300 | 21400 |
| | 25 | 15300 | 22900 |
| | (40) | 17600 | 26300 |
| | (50) | 18900 | 28200 |

* The ratio specified in parentheses is for the HPG Series.

[Note: Table 153-1, -2 and -3 Table 154-1 and -2]

- *1 The basic dynamic load rating means a certain static radial load so that the basic dynamic rated life of the roller bearing is a million rotations.
- *2 The basic static load rating means a static load that gives a certain level of contact stress (4kN/mm²) in the center of the contact area between rolling element receiving the maximum load and orbit.
- *3 The allowable moment load is a maximum moment load applied to the bearing. Within the allowable range, basic performance is maintained and the bearing is operable. Check the bearing life based on the calculations shown on the next page.
- *4 The value of the moment stiffness is the average value.
- *5 The allowable radial load and allowable axial load are the values that satisfy the life of a speed reducer when a pure radial load or an axial load applies to the main bearing. (Lr + R = 0 mm for radial load and La = 0 mm for axial load) If a compound load applies, refer to the calculations shown on the next page.



CSG-GH/CSF-GH Series Table 154-1 indicates the specifications for cross roller bearing.

Table 154-1

| Size | Pitch circle | Offset amount | Basic load rating | | | | Allowable moment load Mc* ³ | | Moment stiffness Km* ⁴ | | Allowable radial load* ⁵ | Allowable axial load* ⁵ |
|------|--------------|---------------|---|------|---|-------|--|------|-----------------------------------|------------------|-------------------------------------|------------------------------------|
| | dp | R | Basic dynamic load rating C* ¹ | | Basic static load rating Co* ² | | Nm | kgfm | ×10 ⁴ Nm/rad | kgfm/ arc min | | |
| | m | m | N | kgf | N | kgf | | | | | N | N |
| 14 | 0.0405 | 0.011 | 5110 | 521 | 7060 | 720 | 27 | 2.76 | 3.0 | 0.89 | 732 | 1093 |
| 20 | 0.064 | 0.0115 | 10600 | 1082 | 17300 | 1765 | 145 | 14.8 | 17 | 5.0 | 1519 | 2267 |
| 32 | 0.085 | 0.014 | 20500 | 2092 | 32800 | 3347 | 258 | 26.3 | 42 | 12 | 2938 | 4385 |
| 45 | 0.123 | 0.019 | 41600 | 4245 | 76000 | 7755 | 797 | 81.3 | 100 | 30 | 5962 | 8899 |
| 65 | 0.170 | 0.0225 | 81600 | 8327 | 149000 | 15204 | 2156 | 220 | 323 | 96 | 11693 | 17454 |

HPF Series Table 154-2 indicates the specifications for cross roller bearing.

Table 154-2

| Size | Pitch circle | Offset amount | Basic load rating | | | | Allowable moment load Mc* ³ | | Moment stiffness Km* ⁴ | | Allowable radial load* ⁵ | Allowable axial load* ⁵ |
|------|--------------|---------------|---|------|---|------|--|------|-----------------------------------|------------------|-------------------------------------|------------------------------------|
| | dp | R | Basic dynamic load rating C* ¹ | | Basic static load rating Co* ² | | Nm | kgfm | ×10 ⁴ Nm/rad | kgfm/ arc min | | |
| | m | m | N | kgf | N | kgf | | | | | N | N |
| 25 | 0.085 | 0.0153 | 11400 | 1163 | 20300 | 2071 | 410 | 41.8 | 37.9 | 11.3 | 1330 | 1990 |
| 32 | 0.1115 | 0.015 | 22500 | 2296 | 39900 | 4071 | 932 | 95 | 86.1 | 25.7 | 2640 | 3940 |

[Note: Table 153-1, -2 and -3 Table 154-1 and -2]

- *1 The basic dynamic load rating means a certain static radial load so that the basic dynamic rated life of the roller bearing is a million rotations.
- *2 The basic static load rating means a static load that gives a certain level of contact stress (4kN/mm²) in the center of the contact area between rolling element receiving the maximum load and orbit.
- *3 The allowable moment load is a maximum moment load applied to the bearing. Within the allowable range, basic performance is maintained and the bearing is operable. Check the bearing life based on the calculations shown on the next page.
- *4 The value of the moment stiffness is the average value.
- *5 The allowable radial load and allowable axial load are the values that satisfy the life of a speed reducer when a pure radial load or an axial load applies to the main bearing. (Lr + R = 0 mm for radial load and La = 0 mm for axial load) If a compound load applies, refer to the calculations shown on the next page.

How to calculate the maximum moment load

- HPGP
- HPG
- CSG-GH
- CSF-GH
- HPF

Maximum moment load (M_{max}) is obtained as follows. Make sure that $M_{max} \leq Mc$.

Formula 155-1

$$M_{max} = Fr_{max}(L_r + R) + Fa_{max}La$$

| | | | |
|------------|------------------|---------|--|
| Fr_{max} | Max. radial load | N (kgf) | See Fig. 155-1. |
| Fa_{max} | Max. axial load | N (kgf) | See Fig. 155-1. |
| L_r, La | — | m | See Fig. 155-1. |
| R | Offset amount | m | See Fig. 155-1. See "Output Bearing Specifications" of each series, p.153 & 154 |

Figure 155-1

External load influence diagram

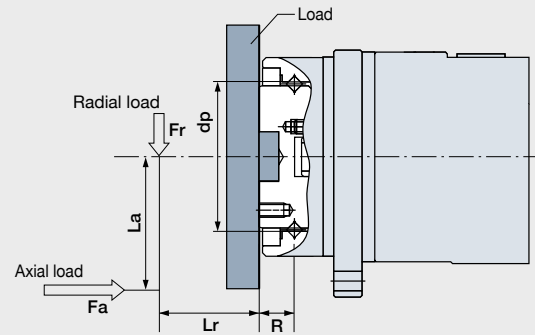

How to calculate the radial and the axial load coefficient

- HPGP
- HPG
- CSG-GH
- CSF-GH
- HPF

The radial load coefficient (X) and the axial load coefficient (Y)

Formula 155-2

| Formula | X | Y |
|--|------|------|
| $\frac{Fa_{av}}{Fr_{av} + 2(Fr_{av}(L_r + R) + Fa_{av} \cdot La) / dp} \leq 1.5$ | 1 | 0.45 |
| $\frac{Fa_{av}}{Fr_{av} + 2(Fr_{av}(L_r + R) + Fa_{av} \cdot La) / dp} > 1.5$ | 0.67 | 0.67 |

| | | | |
|-----------|--------------------------|---------|--|
| Fr_{av} | Average radial load | N (kgf) | See "How to calculate the average load below." |
| Fa_{av} | Average axial load | N (kgf) | See "How to calculate the average load below." |
| L_r, La | — | m | See Fig. 155-1. |
| R | Offset amount | m | See Fig. 155-1. See "Output Bearing Specifications" of each series, p. 153 & 154. |
| dp | Circular pitch of roller | m | See Fig. 155-1. See "Output Bearing Specifications" of each series, p. 153 & 154. |

How to calculate the average load (Average radial load, average axial load, average output speed)

- HPGP
- HPG
- CSG-GH
- CSF-GH
- HPF

If the radial load and the axial load fluctuate, they should be converted into the average load to check the life of the cross roller bearing.

How to obtain the average radial load (Fr_{av}) Formula 155-3

$$Fr_{av} = \sqrt[10/3]{\frac{n_1 t_1 (|Fr_1|)^{10/3} + n_2 t_2 (|Fr_2|)^{10/3} + \dots + n_n t_n (|Fr_n|)^{10/3}}{n_1 t_1 + n_2 t_2 + \dots + n_n t_n}}$$

Note that the maximum radial load within the t_1 section is Fr_1 and the maximum radial load within the t_3 section is Fr_3 .

How to obtain the average axial load (Fa_{av}) Formula 155-4

$$Fa_{av} = \sqrt[10/3]{\frac{n_1 t_1 (|Fa_1|)^{10/3} + n_2 t_2 (|Fa_2|)^{10/3} + \dots + n_n t_n (|Fa_n|)^{10/3}}{n_1 t_1 + n_2 t_2 + \dots + n_n t_n}}$$

Note that the maximum axial load within the t_1 section is Fa_1 and the maximum axial load within the t_3 section is Fa_3 .

How to obtain the average output speed (N_{av}) Formula 155-5

$$N_{av} = \frac{n_1 t_1 + n_2 t_2 + \dots + n_n t_n}{t_1 + t_2 + \dots + t_n}$$

How to calculate the life HPGP HPG CSG-GH CSF-GH HPF

Calculate the life of the cross roller bearing using Formula 156-1. You can obtain the dynamic equivalent load (P_c) using Formula 156-2.

Formula 156-1

$$L_{10} = \frac{10^6}{60 \times N_{av}} \times \left(\frac{C}{f_w \cdot P_c} \right)^{10/3}$$

| | | | |
|-----------------------|---------------------------|---------|---------------------------------------|
| L₁₀ | Life | hour | — |
| N_{av} | Ave. output speed | rpm | See "How to calculate the ave. load." |
| C | Basic dynamic load rating | N (kgf) | See "Output Bearing Specs." |
| P_c | Dynamic equivalent load | N (kgf) | See Formula 156-2. |
| f_w | Load coefficient | — | See Table 156-1. |

Formula 156-2

$$P_c = X \cdot \left(F_{rav} + \frac{2(F_{rav}(L_r + R) + F_{aav} \cdot L_a)}{d_p} \right) + Y \cdot F_{aav}$$

| | | | |
|-------------------------------------|-------------------------|---------|---|
| F_{rav} | Average radial load | N (kgf) | See "How to calculate the ave. load." |
| F_{aav} | Average axial load | N (kgf) | |
| d_p | Pitch Circle of roller | m | See "Output Bearing Specs." |
| X | Radial load coefficient | — | See "How to calculate the radial load coefficient and the axial load coefficient." |
| Y | Axial load coefficient | — | |
| L_r, L_a | — | m | See Figure 155-1. See "External load influence diagram." |
| R | Offset amount | m | See Figure 155-1. See "External load influence diagram" and "Output Bearing Specs" of each series. |

Load coefficient Table 156-1

| Load status | f _w |
|---|----------------|
| During smooth operation without impact or vibration | 1 to 1.2 |
| During normal operation | 1.2 to 1.5 |
| During operation with impact or vibration | 1.5 to 3 |

How to calculate the life during oscillating motion HPGP HPG CSG-GH CSF-GH HPF

Calculate the life of the cross roller bearing during oscillating motion by Formula 156-3.

Formula 156-3

$$L_{oc} = \frac{10^6}{60 \times n_1} \times \frac{90}{\theta} \times \left(\frac{C}{f_w \cdot P_c} \right)^{10/3}$$

| | | | |
|-----------------------|---|---------|-----------------------------|
| L_{oc} | Rated life under oscillating motion | hour | — |
| n₁ | No. of reciprocating oscillation per min. | cpm | — |
| C | Basic dynamic load rating | N (kgf) | See "Output Bearing Specs." |
| P_c | Dynamic equivalent load | N (kgf) | See Formula 156-2. |
| f_w | Load coefficient | — | See Table 156-1. |
| θ | Oscillating angle /2 | Deg. | See Figure 156-1. |

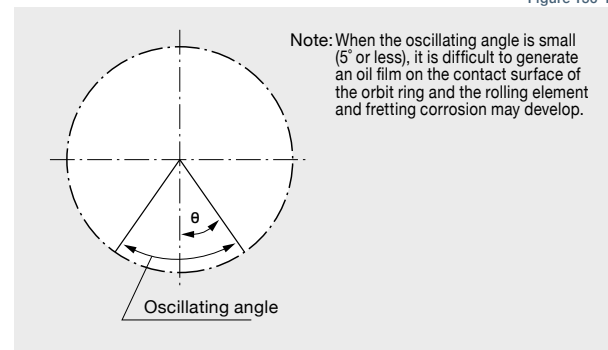

Note When it is used for a long time while the rotation speed of the output shaft is in the ultra-low operation range (0.02rpm or less), the lubrication of the bearing becomes insufficient, resulting in deterioration of the bearing or increased load in the output side. When using it in the ultra-low operation range, contact us.

How to calculate the static safety coefficient HPGP HPG CSG-GH CSF-GH HPF

In general, the basic static load rating (C_0) is considered to be the permissible limit of the static equivalent load. However, obtain the limit based on the operating and required conditions. Calculate the static safety coefficient (f_s) of the cross roller bearing using Formula 156-4.

General values under the operating condition are shown in Table 156-2. You can calculate the static equivalent load (P_0) using Formula 156-5.

Formula 156-4

$$f_s = \frac{C_0}{P_0}$$

| | | | |
|----------------------|------------------------|---------|-----------------------------|
| C₀ | Basic static load | N (kgf) | See "Output Bearing Specs." |
| P₀ | Static equivalent load | N (kgf) | See Formula 156-5. |

Formula 156-5

$$P_0 = F_{rmax} + \frac{2M_{max}}{d_p} + 0.44F_{amax}$$

| | | | |
|-------------------------|------------------|-----------|--|
| F_{rmax} | Max. radial load | N (kgf) | |
| F_{amax} | Max. axial load | N (kgf) | See "How to calculate the max. moment load." |
| M_{max} | Max. moment load | Nm (kgfm) | |
| d_p | Pitch Circle | m | See "Output Bearing Specs" of each series. |

Static safety coefficient Table 156-2

| Load status | f _s |
|--------------------------------------|----------------|
| When high precision is required | ≥ 3 |
| When impact or vibration is expected | ≥ 2 |
| Under normal operating condition | ≥ 1.5 |

Input Bearing Specifications and Checking Procedure

Check the maximum load and life of the bearing on the input side if the reducer is an HPG input shaft unit or an HPF hollow shaft unit.

Checking procedure

HPG

HPF

(1) Checking maximum load

Calculate:

Maximum moment load (Mi_{max})
Maximum axial load (Fai_{max})
Maximum radial load (Fri_{max})



Maximum moment load (Mi_{max}) \leq Allowable moment load (Mc)
Maximum axial load (Fai_{max}) \leq Allowable axial load (Fac)
Maximum radial load (Fri_{max}) \leq Allowable radial load (Frc)

(2) Checking the life

Calculate:

Average moment load (Mi_{av})
Average axial load (Fai_{av})
Average input speed (Ni_{av})



Calculate the life and check it.

Specification of input bearing

Specification of input bearing

HPG

Table 157-1

| Size | Basic load rating | | | |
|------|--------------------------------|------|--------------------------------|------|
| | Basic dynamic load rating Cr | | Basic static load rating Cor | |
| | N | kgf | N | kgf |
| 11 | 2700 | 275 | 1270 | 129 |
| 14 | 5800 | 590 | 3150 | 320 |
| 20 | 9700 | 990 | 5600 | 570 |
| 32 | 22500 | 2300 | 14800 | 1510 |
| 50 | 35500 | 3600 | 25100 | 2560 |
| 65 | 51000 | 5200 | 39500 | 4050 |

Table 157-2

| Size | Allowable moment load Mc | | Allowable axial load Fac^{*1} | | Allowable radial load Frc^{*2} | |
|------|----------------------------|-------|---------------------------------|-----|----------------------------------|-----|
| | Nm | kgfm | N | kgf | N | kgf |
| 11 | 0.16 | 0.016 | 245 | 25 | 20.6 | 2.1 |
| 14 | 6.3 | 0.64 | 657 | 67 | 500 | 51 |
| 20 | 13.5 | 1.38 | 1206 | 123 | 902 | 92 |
| 32 | 44.4 | 4.53 | 3285 | 335 | 1970 | 201 |
| 50 | 96.9 | 9.88 | 5540 | 565 | 3226 | 329 |
| 65 | 210 | 21.4 | 8600 | 878 | 5267 | 537 |

Specification of input shaft bearing

HPF

Table 157-3

| Size | Basic load rating | | | |
|------|--------------------------------|------|--------------------------------|------|
| | Basic dynamic load rating Cr | | Basic static load rating Cor | |
| | N | kgf | N | kgf |
| 25 | 14500 | 1480 | 10100 | 1030 |
| 32 | 29700 | 3030 | 20100 | 2050 |

Table 157-4

| Size | Allowable moment load Mc | | Allowable axial load Fac^{*1} | | Allowable radial load Frc^{*3} | |
|------|----------------------------|------|---------------------------------|-----|----------------------------------|------|
| | Nm | kgfm | N | kgf | N | kgf |
| 25 | 10 | 1.02 | 1538 | 157 | 522 | 53.2 |
| 32 | 19 | 1.93 | 3263 | 333 | 966 | 98.5 |

[Note: Table 157-2 and 157-4]

*1 The allowable axial load is the value of an axial load applied along the axis of rotation.

*2 The allowable radial load of HPG series is the value of a radial load applied at the mid-point of the input shaft.

*3 The allowable radial load of HPG series is the value of a radial load applied to the point of 20 mm from the shaft edge (input flange edge).

Calculating maximum moment load ON input shaft

The maximum moment load ($M_{i max}$) is calculated as follows.
Check that the following formulas are established in all circumstances:

Formula 158-1

$$M_{i max} = F_{ri max} \cdot L_{ri} + F_{ai max} \cdot L_{ai}$$

| | | | |
|------------------|------------------|---------|-----------------|
| $F_{ri max}$ | Max. radial load | N (kgf) | See Fig. 158-1. |
| $F_{ai max}$ | Max. axial load | N (kgf) | See Fig. 158-1. |
| L_{ri}, L_{ai} | ----- | m | See Fig. 158-1. |

$$M_{i max} \leq M_c \text{ (Allowable moment load)}$$

$$F_{ai max} \leq F_{ac} \text{ (Allowable axial load)}$$

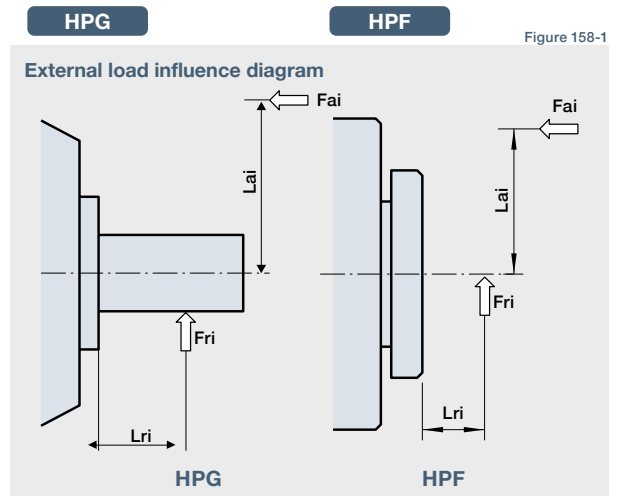

How to calculate average load (Average moment load, average axial load, average input speed)

If moment load and axial load fluctuate, they should be converted into the average load to check the life of the bearing.

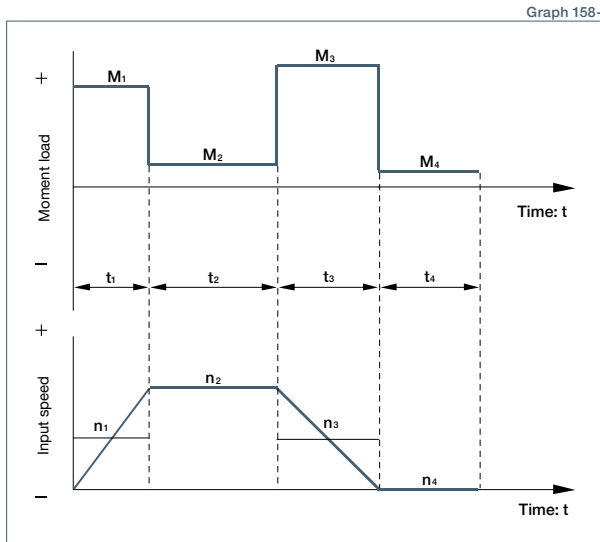

Formula 158-2

How to calculate the average moment load ($M_{i av}$)

$$M_{i av} = \sqrt[3]{\frac{n_1 t_1 (|M_{i1}|)^3 + n_2 t_2 (|M_{i2}|)^3 + \dots + n_n t_n (|M_{in}|)^3}{n_1 t_1 + n_2 t_2 + \dots + n_n t_n}}$$

Formula 158-3

How to calculate the average axial load ($F_{ai av}$)

$$F_{ai av} = \sqrt[3]{\frac{n_1 t_1 (|F_{ai1}|)^3 + n_2 t_2 (|F_{ai2}|)^3 + \dots + n_n t_n (|F_{ain}|)^3}{n_1 t_1 + n_2 t_2 + \dots + n_n t_n}}$$

Formula 158-4

How to calculate the average input speed ($N_{i av}$)

$$N_{i av} = \frac{n_1 t_1 + n_2 t_2 + \dots + n_n t_n}{t_1 + t_2 + \dots + t_n}$$

Calculating life of input bearing

Calculate the bearing life according to Calculation Formula 158-5 and check the life.

Formula 158-5

$$L_{10} = \frac{10^6}{60 \times N_{i av}} \times \left(\frac{C_r}{P_{ci}} \right)^3$$

| | | | |
|------------|---------------------------|---------|------------------------|
| L_{10} | Life | Hour | — |
| $N_{i av}$ | Average input speed | rpm | See Formula 158-4 |
| C_r | Basic dynamic load rating | N (kgf) | See Table 157-1 and -3 |
| P_{ci} | Dynamic equivalent load | N | See Table 158-1 and -2 |

Table 158-1

Dynamic equivalent load **HPG**

| Size | P_{ci} |
|------|--|
| 11 | $0.444 \times M_{i av} + 1.426 \times F_{ai av}$ |
| 14 | $0.137 \times M_{i av} + 1.232 \times F_{ai av}$ |
| 20 | $0.109 \times M_{i av} + 1.232 \times F_{ai av}$ |
| 32 | $0.071 \times M_{i av} + 1.232 \times F_{ai av}$ |
| 50 | $0.053 \times M_{i av} + 1.232 \times F_{ai av}$ |
| 65 | $0.041 \times M_{i av} + 1.232 \times F_{ai av}$ |

Table 158-2

Dynamic equivalent load **HPF**

| Size | P_{ci} |
|------|--|
| 25 | $121 \times M_{i av} + 2.7 \times F_{ai av}$ |
| 32 | $106 \times M_{i av} + 2.7 \times F_{ai av}$ |

$M_{i av}$ Average moment load Nm (kgfm) See Formula 158-2
 $F_{ai av}$ Average axial load N (kgf) See Formula 158-3

Assembly

Assemble and mount your gearhead in accordance with these instructions to achieve the best performance. Be sure to use the recommended bolts and use a torque wrench to achieve the proper tightening torques as recommended in tables below.

Motor assembly procedure HPGP HPG CSG-GH CSF-GH HPN

To properly mount the motor to the gearhead, follow the procedure outlined below, refer to figure 159-1

- (1) Turn the input shaft coupling and align the bolt head with the rubber cap hole.
- (2) With the speed reducer in an upright position as illustrated in the figure below, slowly insert the motor shaft into the coupling of speed reducer. Slide the motor shaft without letting it drop down. If the speed reducer cannot be positioned upright, slowly insert the motor shaft into the coupling of speed reducer, then tighten the motor bolts evenly until the motor flange and gearhead flange are in full contact. Exercise care to avoid tilting the motor when inserting it into the gear head.

- (3) Tighten the input shaft coupling bolt to the recommended torque specified in the table below. The bolt(s) or screw(s) is (are) already inserted into the input coupling when delivered. Check the bolt size on the confirmation drawing provided.

Bolt tightening torque

Table 159-1

| Bolt size | M3 | M4 | M5 | M6 | M8 | M10 | M12 |
|-------------------|------|------|------|------|------|------|------|
| Tightening torque | Nm | 2.0 | 4.5 | 9.0 | 15.3 | 37.2 | 73.5 |
| | kgfm | 0.20 | 0.46 | 0.92 | 1.56 | 3.8 | 7.5 |

Caution: Always tighten the bolts to the tightening torque specified in the table above. If the bolt is not tightened to the torque value recommended slippage of the motor shaft in the shaft coupling may occur. The bolt size will vary depending on the size of the gear and the shaft diameter of the mounted motor. Check the bolt size on the confirmation drawing provided.

Two setscrews need to be tightened on size 11. See the outline dimensions on page 22 (HPGP) and page 34 (HPG standard) and page 46 (HPG helical). Tighten the screws to the tightening torque specified below.

Table 159-2

| Bolt size | M3 | |
|-------------------|------|------|
| Tightening torque | Nm | 0.69 |
| | kgfm | 0.07 |

- (4) Fasten the motor to the gearhead flange with bolts.

Bolt* tightening torque

Table 159-3

| Bolt size | M2.5 | M3 | M4 | M5 | M6 | M8 | M10 | M12 |
|-------------------|------|------|------|------|------|------|------|------|
| Tightening torque | Nm | 0.59 | 1.4 | 3.2 | 6.3 | 10.7 | 26.1 | 89.9 |
| | kgfm | 0.06 | 0.14 | 0.32 | 0.64 | 1.09 | 2.66 | 9.17 |

* Recommended bolt: JIS B 1176 Hexagon socket head bolt, Strength: JIS B 1051 12.9 or higher

Caution: Be sure to tighten the bolts to the tightening torques specified in the table.

- (5) Insert the rubber cap provided. This completes the assembly. (Size 11: Fasten screws with a gasket in two places)

Figure 159-1

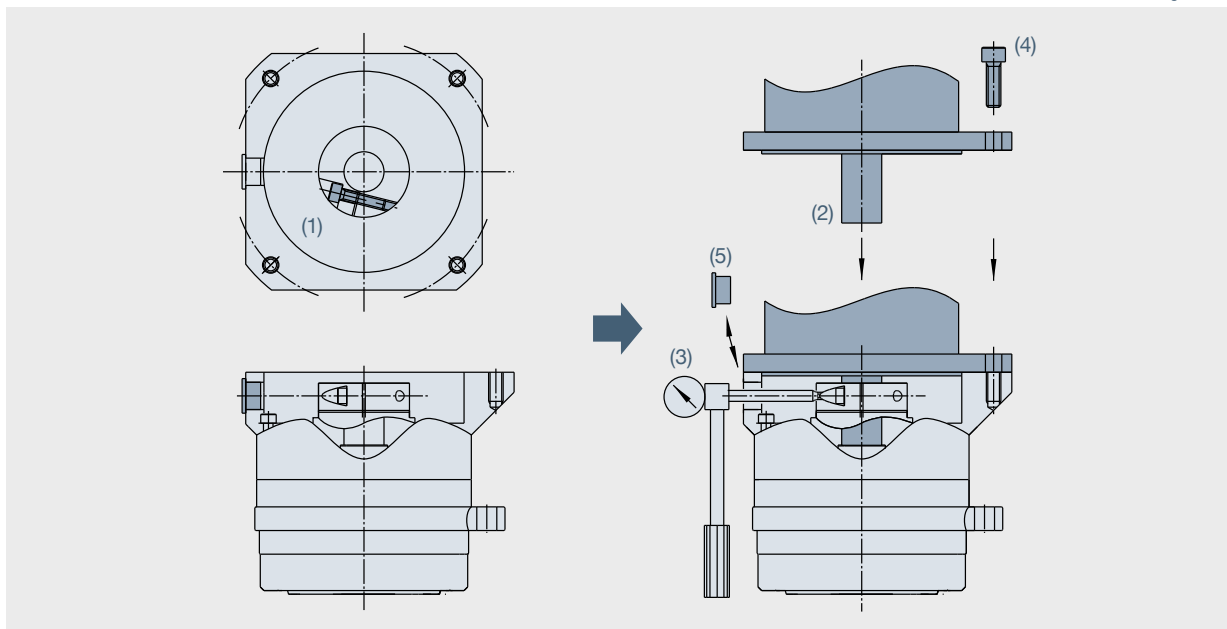

Speed reducer assembly

HPGP
HPG
CSG-GH
CSF-GH
HPF
HPN

Some right angle gearhead models weigh as much as 60 kg. No thread for an eyebolt is provided because the mounting orientation varies depending on the customer's needs. When mounting the reducer, hoist it using a sling paying extreme attention to safety.

When assembling gearheads into your equipment, check the flatness of your mounting surface and look for any burrs on tapped holes. Then fasten the flange (Part A in the diagram below) using appropriate bolts.

Bolt* tightening torque for flange (Part A in the diagram below)

Table 160-1

| Size | HPN | | | | | HPGP / HPG / CSG-GH / CSF-GH | | | | | | HPF | | |
|---------------------|------|------|------|------|------|------------------------------|------|------|------|-------|------|------|------|------|
| | 11 | 14 | 20 | 32 | 40 | 11 | 14 | 20 | 32 | 45/50 | 65 | 25 | 32 | |
| Number of bolts | 4 | 4 | 4 | 4 | 4 | 4 | 4 | 4 | 4 | 4 | 4 | 12 | 12 | |
| Bolt size | M3 | M5 | M6 | M8 | M10 | M3 | M5 | M8 | M10 | M12 | M16 | M4 | M5 | |
| Mounting PCD | mm | 50 | 70 | 100 | 130 | 165 | 46 | 70 | 105 | 135 | 190 | 260 | 127 | 157 |
| Tightening torque | Nm | 1.4 | 6.3 | 10.7 | 26.1 | 51.5 | 1.4 | 6.3 | 26.1 | 51.5 | 103 | 255 | 4.5 | 9.0 |
| | kgfm | 0.14 | 0.64 | 1.09 | 2.66 | 5.26 | 0.14 | 0.64 | 2.66 | 5.25 | 10.5 | 26.0 | 0.46 | 0.92 |
| Transmission torque | Nm | 27.9 | 110 | 223 | 528 | 1063 | 26.3 | 110 | 428 | 868 | 2030 | 5180 | 531 | 1060 |
| | kgfm | 2.85 | 11.3 | 22.8 | 53.9 | 108.5 | 2.69 | 11.3 | 43.6 | 88.6 | 207 | 528 | 54.2 | 108 |

* Recommended bolts: JIS B 1176 "Hexagon socket head bolts." Strength classification 12.9 or higher in JIS B 1051.

Mounting the load to the output flange

Follow the specifications in the table below when mounting the load onto the output flange.

Figure 160-1

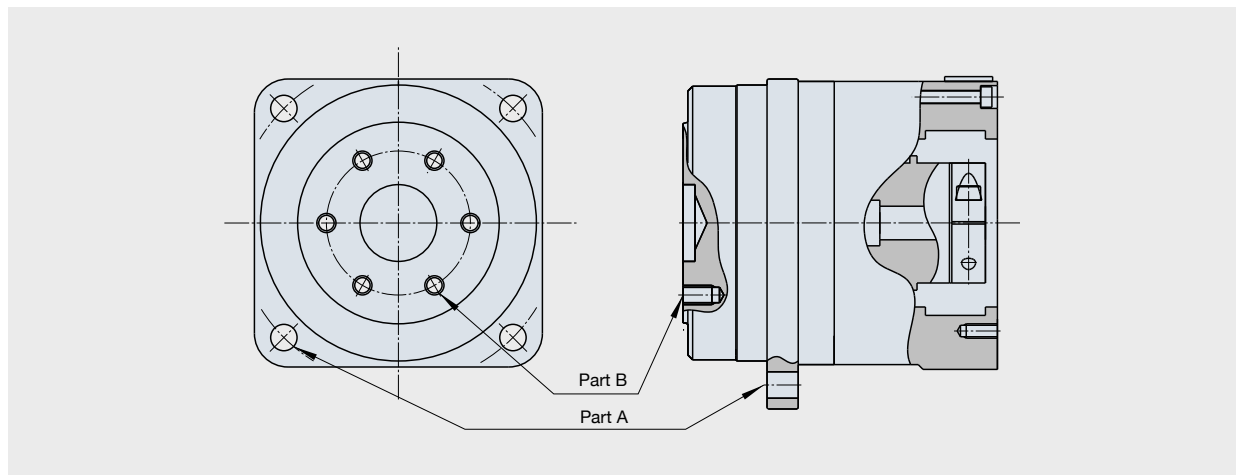

Output flange mounting specifications

Bolt* tightening torque for output flange (Part B in the Figure 160-1)

HPGP

Table 160-2

| Size | 11 | 14 | 20 | 32 | 50 | 65 | |
|---------------------|------|------|------|------|------|-------|------|
| Number of bolts | 4 | 8 | 8 | 8 | 8 | 8 | |
| Bolt size | M4 | M4 | M6 | M8 | M12 | M16 | |
| Mounting PCD | mm | 18 | 30 | 45 | 60 | 90 | 120 |
| Tightening torque | Nm | 4.5 | 4.5 | 15.3 | 37.2 | 128.4 | 319 |
| | kgfm | 0.46 | 0.46 | 1.56 | 3.8 | 13.1 | 32.5 |
| Transmission torque | Nm | 25.3 | 84 | 286 | 697 | 2407 | 5972 |
| | kgfm | 2.58 | 8.6 | 29.2 | 71.2 | 245 | 609 |

* Recommended bolts: JIS B 1176 "Hexagon socket head bolts." Strength classification 12.9 or higher in JIS B 1051.

Bolt* tightening torque for output flange (Part B in the Figure 160-1)

HPG

Table 160-3

| Size | 11 | 14 | 20 | 32 | 50 | 65 | |
|---------------------|------|------|------|------|------|-------|------|
| Number of bolts | 3 | 6 | 6 | 6 | 14 | 6 | |
| Bolt size | M4 | M4 | M6 | M8 | M8 | M16 | |
| Mounting PCD | mm | 18 | 30 | 45 | 60 | 100 | 120 |
| Tightening torque | Nm | 4.5 | 4.5 | 15.3 | 37.2 | 37.2 | 319 |
| | kgfm | 0.46 | 0.46 | 1.56 | 3.8 | 3.80 | 32.5 |
| Transmission torque | Nm | 19.0 | 63 | 215 | 524 | 2036 | 4480 |
| | kgfm | 1.9 | 6.5 | 21.9 | 53.4 | 207.8 | 457 |

* Recommended bolts: JIS B 1176 "Hexagon socket head bolts." Strength classification 12.9 or higher in JIS B 1051.

Mounting the load to the output flange

Bolt* tightening torque for output flange (Part B in Figure 160-1)

CSG-GH

Table 161-1

| Size | | 14 | 20 | 32 | 45 | 65 |
|---------------------|------|------|------|------|------|------|
| Number of bolts | | 8 | 8 | 10 | 10 | 10 |
| Bolt size | | M4 | M6 | M8 | M12 | M16 |
| Mounting PCD | mm | 30 | 45 | 60 | 94 | 120 |
| | Nm | 4.5 | 15.3 | 37 | 128 | 319 |
| Tightening torque | kgfm | 0.46 | 1.56 | 3.8 | 3.1 | 32.5 |
| | Nm | 84 | 287 | 867 | 3067 | 7477 |
| Transmission torque | kgfm | 8.6 | 29.3 | 88.5 | 313 | 763 |

Bolt* tightening torque for output flange (Part B in Figure 160-1)

CSF-GH

Table 161-2

| Size | | 14 | 20 | 32 | 45 | 65 |
|---------------------|------|------|------|------|------|------|
| Number of bolts | | 6 | 6 | 6 | 16 | 8 |
| Bolt size | | M4 | M6 | M8 | M8 | M16 |
| Mounting PCD | mm | 30 | 45 | 60 | 100 | 120 |
| | Nm | 4.5 | 15.3 | 37.2 | 37.2 | 319 |
| Tightening torque | kgfm | 0.46 | 1.56 | 3.80 | 3.80 | 32.5 |
| | Nm | 63 | 215 | 524 | 2326 | 5981 |
| Transmission torque | kgfm | 6.5 | 21.9 | 53.4 | 237 | 610 |

Bolt* tightening torque for output flange
(Part B in Figure 160-1)

HPF

Table 161-3

| Size | | 25 | 32 |
|---------------------|------|------|------|
| Number of bolts | | 12 | 12 |
| Bolt size | | M4 | M5 |
| Mounting PCD | mm | 77 | 100 |
| | Nm | 4.5 | 9.0 |
| Tightening torque | kgfm | 0.46 | 0.92 |
| | Nm | 322 | 675 |
| Transmission torque | kgfm | 32.9 | 68.9 |

* Recommended bolts: JIS B 1176 "Hexagon socket head bolts." Strength classification 12.9 or higher in JIS B 1051.

Gearheads with an output shaft

HPN

HPG

HPGP

CSG-GH

CSF-GH

HPF

Do not subject the output shaft to any impact when mounting a pulley, pinion or other parts.

An impact to the the output bearing may affect the speed reducer precision and may cause reduced life or failure.

Mechanical Tolerances

Superior mechanical precision is achieved by integrating the output flange with a high-precision cross roller bearing as a single component. The mechanical tolerances of the output shaft and mounting flange are specified below.

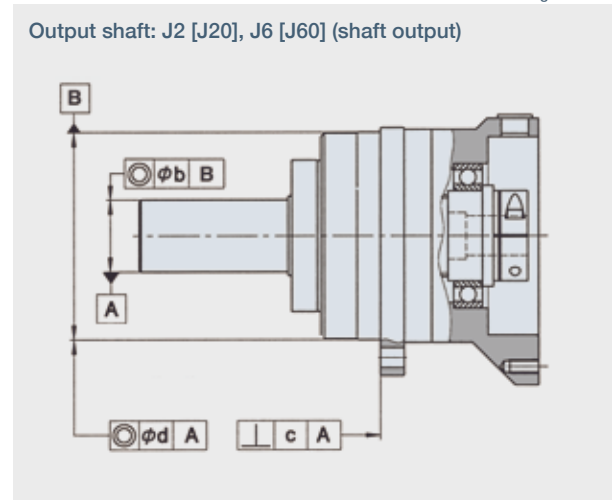
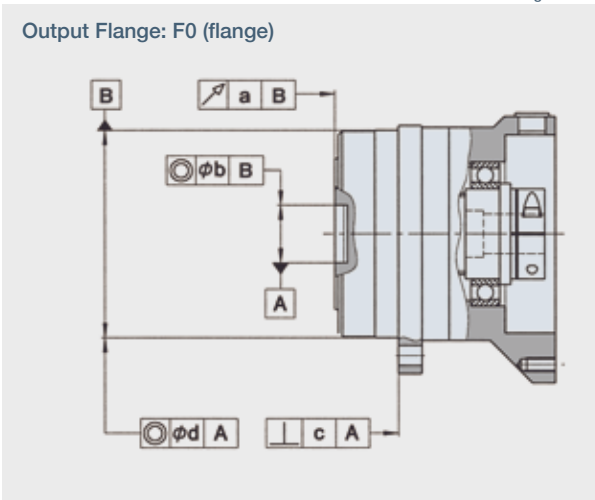

HPGP **HPG** **CSG-GH** **CSF-GH**

Table 162-1

| Size | Axial runout of output flange a | Radial runout of output flange pilot or output shaft b | Perpendicularity of mounting flange c | Concentricity of mounting flange d |
|------|------------------------------------|--|---|---------------------------------------|
| 11 | 0.020 | 0.030 | 0.050 | 0.040 |
| 14 | 0.020 | 0.040 | 0.060 | 0.050 |
| 20 | 0.020 | 0.040 | 0.060 | 0.050 |
| 32 | 0.020 | 0.040 | 0.060 | 0.050 |

HPGP **HPG**

Table 162-2

| | | | | |
|----|-------|-------|-------|-------|
| 50 | 0.020 | 0.040 | 0.060 | 0.050 |
| 65 | 0.040 | 0.060 | 0.090 | 0.080 |

CSG-GH **CSF-GH**

Table 162-3

| | | | | |
|----|-------|-------|-------|-------|
| 45 | 0.020 | 0.040 | 0.060 | 0.050 |
| 65 | 0.020 | 0.040 | 0.060 | 0.050 |

HPF

Table 162-4

| | | | | |
|----|-------|-------|-------|-------|
| 25 | 0.020 | 0.040 | 0.060 | 0.050 |
| 32 | 0.020 | 0.040 | 0.060 | 0.050 |

* T.I.R.: Total indicator reading

(T.I.R.* Unit: mm)

Lubrication

Prevention of grease and oil leakage

(Common to all models)

- Only use the recommended greases.
- Provisions for proper sealing to prevent grease leakage are incorporated into the gearheads. However, please note that some leakage may occur depending on the application or operating condition. Discuss other sealing options with our applications engineers.
- When mounting the gearhead horizontally, position the gearhead so that the rubber cap in the adapter flange is facing upwards.

(CSG/CSF-GH Series)

- Contact us when using HarmonicDrive® CSG/CSF-GH series with the output shaft facing downward (motor on top) at a constant load or rotating continuously in one direction.

Sealing

(Common to all models)

- Provisions for proper sealing to prevent grease leakage from the input shaft are incorporated into the gearhead.
- A double lip Teflon oil seal is used for the output shaft (HPGP/HPG uses a single lip seal), gaskets or o-rings are used on all mating surfaces, and non contact shielded bearings are used for the motor shaft coupling (Double sealed bearings (D type) are available as an option*). On the CSG/CSF-GH series, non contact shielded bearing and a Teflon oil seal with a spring is used.
- Material and surface: Gearbox: Aluminum, corrosion protected roller bearing steel, carbon steel (output shaft). Adapter flange: (if provided by Harmonic Drive) high-strength aluminum or carbon steel. Screws: black phosphate. The ambient environment should not subject any corrosive agents to the above mentioned material. The product provides protection class IP 54 under the provision that corrosion from the ambient atmosphere (condensation, liquids or gases) at the running surface of the output shaft seal is prevented. If necessary, the adapter flange can be sealed by means of a surface seal (e.g. Loctite 515).

* D type: Bearing with a rubber contact seal on both sides

(HPG/HPGP/HPF/HPN Series)

- Using the double sealed bearing (D type) for the HPGP/HPG series gearhead will result in a slightly lower efficiency compared to the standard product.
- An oil seal without a spring is used ON the input side of HPG series with an input shaft (HPG-1U) and HPF series hollow shaft reducer. An option for an oil seal with a spring is available for improved seal reliability, however, the efficiency will be slightly lower (available for HPF and HPG series for sizes 14 and larger).
- Do not remove the screw plug and seal cap of the HPG series right angle gearhead. Removing them may cause leakage of grease or affect the precision of the gear.

Standard Lubricants

HPG/HPGP/HPF/HPN Series

The standard lubrication for the HPG/HPGP/HPF/HPN series gearheads is grease.
All gearheads are lubricated at the factory prior to shipment and additional application of grease during assembly is not required.
The gearheads are lubricated for the life of the gear and do not require re-lubrication.
High efficiency is achieved through the unique planetary gear design and grease selection.

Lubricants

Harmonic Grease SK-2 (HPGP/HPG-14, 20, 32)
Manufacturer: Harmonic Drive Systems Inc.

| | |
|--|---------------------------------|
| Base oil: Refined mineral oil | Consistency: 265 to 295 at 25°C |
| Thickening agent: Lithium soap | Dropping point: 198°C |
| Additive: Extreme pressure agent and other | Color: Green |
| Standard: NLGI No. 2 | |

EPNOC Grease AP (N) 2 (HPGP/HPG-11, 50, 65/HPF-25, 32)
Manufacturer: Nippon Oil Co.

| | |
|--|--------------------------|
| Base oil: Refined mineral oil | Consistency: 282 at 25°C |
| Thickening agent: Lithium soap | Dropping point: 200°C |
| Additive: Extreme pressure agent and other | Color: Light brown |
| Standard: NLGI No. 2 | |

PYRONOC UNIVERSAL 00 (HPG right angle gearhead/HPN)
Manufacturer: Nippon Oil Co.

| | |
|-------------------------------|---------------------------------|
| Base oil: Refined mineral oil | Consistency: 420 at 25°C |
| Thickening agent: Urea | Dropping point: 250°C or higher |
| Standard: NLGI No. 00 | Color: Light yellow |

MULTEMP AC-P (HPG-X-R)
Manufacturer: KYODO YUSHI CO, LTD

| | |
|---|--------------------------|
| Base oil: Composite hydrocarbon oil and diester | Standard: NLGI No. 2 |
| Thickening agent: Lithium soap | Consistency: 280 at 25°C |
| Additive: Extreme pressure and others | Dropping point: 200°C |
| | Color: Black viscose |

Ambient operating temperature range: -10°C to +40°C

The lubricant may deteriorate if the ambient operating temperature is outside of recommended operating range. Please contact our sales office or distributor for operation outside of the ambient operating temperature range.

The temperature rise of the gear depends upon the operating cycle, ambient temperature and heat conduction and radiation based on the customers installation of the gear. A housing surface temperature of 70°C is the maximum allowable limit.

CSG-GH/CSF-GH Series

The standard lubrication for the CGS-GH / CSF-GH series gearheads is grease. All gearheads are lubricated at the factory prior to shipment and additional application of grease during assembly is not necessary.

Lubricants

Harmonic Grease SK-1A (Size 20, 32, 45, 65)
 Manufacturer: Harmonic Drive Systems Inc.

This grease has been developed exclusively for HarmonicDrive® gears and is excellent in durability and efficiency compared to commercial general-purpose grease.

Base oil: Refined mineral oil
 Thickening Agent: Lithium soap
 Additive: Extreme pressure agent and other
 Standard: NLGI No. 2

Consistency: 265 to 295 at 25°C
 Dropping point: 197°C
 Color: Yellow

Harmonic Grease SK-2 (Size 14)
 Manufacturer: Harmonic Drive Systems Inc.

This grease has been developed exclusively for smaller sized HarmonicDrive® gears and allows smooth wave generator rotation.

Base oil: Refined mineral oil
 Thickening Agent: Lithium soap
 Additive: Extreme pressure agent and other
 Standard: NLGI No. 2

Consistency: 265 to 295 at 25°C
 Dropping point: 198°C
 Color: Green

Ambient operating temperature range: -10°C to +40°C

The lubricant may deteriorate if the ambient operating temperature is outside the recommended temperature range. Please contact our sales office or distributor for operation outside of the ambient operating temperature range.

The temperature rise of the gear depends upon the operating cycle, ambient temperature and heat conduction and radiation based on the customers installation of the gear. A housing surface temperature of 70°C is the maximum allowable limit.

When to change the grease

The life of the Harmonic Drive® gear is affected by the grease performance. The grease performance varies with temperature and deteriorates at elevated temperatures. Therefore, the grease will need to be changed sooner than usual when operating at higher temperatures. The graph on the right indicates when to change the grease based upon the temperature (when the average load torque is less than or equal to the rated output torque at 2000 rpm). Also, using the formula below, you can calculate when to change the grease when the average load torque exceeds the rated output torque (at 2000 rpm).

Formula to calculate the grease change interval when the average load torque exceeds the rated torque Formula 164-1

$$L_{GT} = L_{GTn} \times \left(\frac{T_r}{T_{av}} \right)^3$$

Formula symbols

Table 164-1

| | | | |
|-----------|---|-----------------|--|
| L_{GT} | Grease change interval when $T_{av} > T_r$ | Input rotations | _____ |
| L_{GTn} | Grease change interval when $T_{av} \leq T_r$ | Input rotations | See Graph 164-1 |
| T_r | Output torque at 2000 rpm | Nm, kgfm | See the "Rating table" on pages 87 & 97. |
| T_{av} | Average load torque | Nm, kgfm | Calculation formula: See page 111. |

When to change the grease:
LGTn (when the average load torque is equal to or less than the rated output torque at 2000 rpm)

Figure 164-1

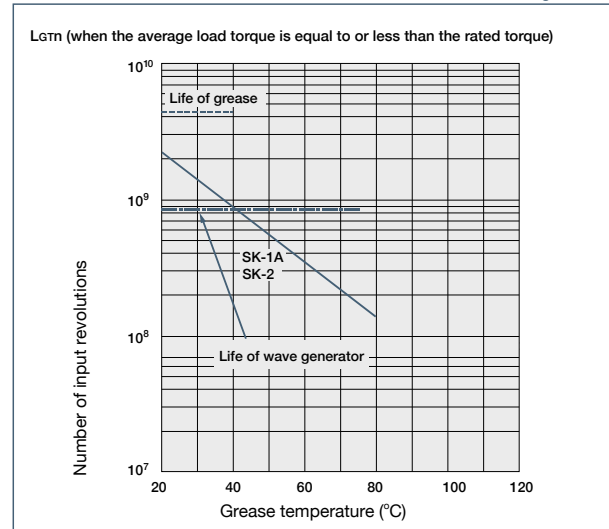

* L10 Life of wave generator bearing

Reference values for grease refill amount

Table 164-2

| | | | | | |
|-----------|-----|-----|-----|------|------|
| Size | 14 | 20 | 32 | 45 | 65 |
| Amount: g | 0.8 | 3.2 | 6.6 | 11.6 | 78.6 |

Precautions when changing the grease

Strictly observe the following instructions when changing the grease to avoid problems such as grease leakage or increase in running torque.

- Note that the amount of grease listed in Table 164-2 is the amount used to lubricate the gear at assembly. This should be used as a reference. Do not exceed this amount when re-greasing the gearhead.
- Remove grease from the gearhead and refill it with the same quantity. The adverse effects listed above normally do not occur until the gear has been re-greased 2 times. When re-greasing 3 times or more, it is essential to remove grease (using air pressure or other means) before re-lubricating with the same amount of grease that was removed.

Warranty

Please contact us or visit our website at www.harmonicdrive.net for warranty details for your specific product.

All efforts have been made to ensure that the information in this catalog is complete and accurate. However, Harmonic Drive LLC is not liable for any errors, omissions or inaccuracies in the reported data. Harmonic Drive LLC reserves the right to change the product specifications, for any reason, without prior notice. For complete details please refer to our current Terms and Conditions posted on our website.

Disposal

When disposing of the product, disassemble it and sort the component parts by material type and dispose of the parts as industrial waste in accordance with the applicable laws and regulations. The component part materials can be classified into three categories.

- (1) Rubber parts: Oil seals, seal packings, rubber caps, seals of shielded bearings on input side (D type only)
- (2) Aluminum parts: Housings, motor flanges
- (3) Steel parts: Other parts

Trademark

HarmonicDrive® is a registered trademark of Harmonic Drive LLC.

HarmonicPlanetary® is a registered trademark of Harmonic Drive LLC.

Safety

 **Warning** : Means that improper use or handling could result in a risk of death or serious injury.

 **Caution** : Means that improper use or handling could result in personal injury or damage to property.





Application Restrictions









This product cannot be used for the following applications:





- * Space flight hardware
- * Aircraft equipment
- * Nuclear power equipment
- * Equipment and apparatus used in residential dwellings
- * Vacuum environments
- * Automotive equipment
- * Personal recreation equipment
- * Equipment that directly works on human bodies
- * Equipment for transport of humans
- * Equipment for use in a special environment
- * Medical equipment

Please consult Harmonic Drive LLC beforehand if intending to use one of our product for the aforementioned applications.

Fail-safe devices that prevent an accident must be designed into the equipment when the products are used in any equipment that could result in personal injury or damage to property in the event of product failure.

| Design Precaution: Be certain to read the catalog when designing the equipment. | |
|--|---|
|  Caution | <p>Use only in the proper environment.</p> <ul style="list-style-type: none"> ● Please ensure to comply with the following environmental conditions: <ul style="list-style-type: none"> • Ambient temperature 0 to 40°C • No splashing of water or oil • Do not expose to corrosive or explosive gas • No dust such as metal powder |
|  Caution | <p>Install the equipment properly.</p> <ul style="list-style-type: none"> ● Carry out the assembly and installation precisely as specified in the catalog. ● Observe our recommended fastening methods (including bolts used and tightening torques). ● Operating the equipment without precise assembly can cause problems such as vibration, reduction in life, deterioration of precision and product failure. |
|  Caution | <p>Install the equipment with the required precision.</p> <ul style="list-style-type: none"> ● Design and assemble parts to keep all catalog recommended tolerances for installation. ● Failure to hold the recommended tolerances can cause problems such as vibration, reduction in life, deterioration of precision and product failure. |
|  Caution | <p>Use the specified lubricant.</p> <ul style="list-style-type: none"> ● Using other than our recommended lubricant can reduce the life of the product. Replace the lubricant as recommended. ● Gearheads are factory lubricated. Do not mix installed lubricant with other kinds of grease. |

| Operational Precaution: Be certain to read the catalog before operating the equipment. | |
|--|--|
|  Caution | <p>Use caution when handling the product and parts.</p> <ul style="list-style-type: none"> ● Do not hit the gear or any part with a hammer. ● If you use the equipment in a damaged condition, the gearhead may not perform to catalog specifications. It can also cause problems including product failure. |
|  Caution | <p>Operate within the allowable torque range.</p> <ul style="list-style-type: none"> ● Do not apply torque exceeding the momentary peak torque. Applying excess torque can cause problems such as loosened bolts, generation of backlash and product failure. ● An arm attached directly to the output shaft that strikes a solid object can damage the arm or cause the output of the gearhead to fail. |
|  Caution | <p>Do not alter or disassemble the product or parts.</p> <ul style="list-style-type: none"> ● Harmonic Planetary® and Harmonic Drive® products are manufactured as matched sets. Catalog ratings may not be achieved if the component parts are interchanged. |
|  Caution | <p>Do not disassemble the products.</p> <ul style="list-style-type: none"> ● Do not disassemble and reassemble the products. Original performance may not be achieved. |
|  Warning | <p>Do not use your finger to turn the gear.</p> <ul style="list-style-type: none"> ● Do not insert your finger into the gear under any circumstances. The finger may get caught in the gear causing an injury. |
|  Caution | <p>Stop operating the system if any abnormality occurs.</p> <ul style="list-style-type: none"> ● Shut down the system promptly if any abnormal sound or vibration is detected, the rotation has stopped, an abnormally high temperature is generated, an abnormal motor current value is observed or any other anomalies are detected. Continuing to operate the system may adversely affect the product or equipment. ● Please contact our sales office or distributor if any anomaly is detected. |
|  Warning | <p>Large sizes (45, 50 and 65) are heavy. Use caution when handling.</p> <ul style="list-style-type: none"> ● They are heavy and may cause a lower-back injury or an injury if dropped on a hand or foot. Wear protective shoes and back support when handling the product. |
|  Caution | <ul style="list-style-type: none"> ● Rust-proofing was applied before shipping. However, please note that rusting may occur depending on the customers' storage environment. ● Although black oxide finish is applied to some of our products, it does not guarantee that rust will not form. |

| Handling Lubricant | |
|--|---|
|  Warning | <p>Precautions on handling lubricants</p> <ul style="list-style-type: none"> ● Lubricant in the eye can cause inflammation. Wear protective glasses to prevent it from getting in your eye. ● Lubricant coming in contact with the skin can cause inflammation. Wear protective gloves when you handle the lubricant to prevent it from contacting your skin. ● Do not ingest (to avoid diarrhea and vomiting). ● Use caution when opening the container. There may be sharp edges that can cut your hand. Wear protective gloves. ● Keep lubricant out of reach of children. |
|  Caution | <p>Disposal of waste oil and containers</p> <ul style="list-style-type: none"> ● Follow all applicable laws regarding waste disposal. Contact your distributor if you are unsure how to properly dispose of the material. ● Do not apply pressure to an empty container. The container may explode. ● Do not weld, heat, drill or cut the container. This may cause residual oil to ignite or cause an explosion. |
|  Warning | <p>First-aid</p> <ul style="list-style-type: none"> ● Inhalation: Remove exposed person to fresh air if adverse effects are observed. ● Ingestion: Seek immediate medical attention and do not induce vomiting unless directed by medical personnel. ● Eyes: Flush immediately with water for at least 15 minutes. Get immediate medical attention. ● Skin: Wash with soap and water. Get medical attention if irritation develops. |
|  Caution | <p>Storage</p> <ul style="list-style-type: none"> ● Tightly seal the container after use. Store in a cool, dry, dark place. Keep away from open flames and high temperatures. |
|  Caution | <p>Disposal</p> <p>Please dispose of as industrial waste.</p> <ul style="list-style-type: none"> ● Please dispose of the products as industrial waste when their useful life is over. |

NOTES

Lined area for notes, featuring a solid top line, a dashed midline, and a solid bottom line for each row.

Major Applications of Our Products



Metal Working Machines



Processing Machine Tools



Measurement, Analytical and Test Systems



Medical Equipment



Telescopes

Source: National observatory of Inter-University Research Institute Corporation

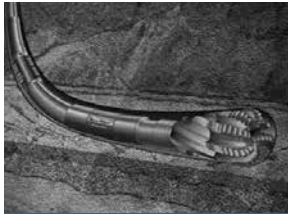

Energy

Courtesy of Halliburton/Sperry Drilling Services

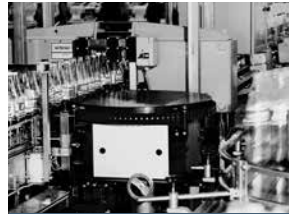

Crating and Packaging Machines



Communication Equipment



Space Flight Hardware

Rover image created by Dan Maas, copyrighted to Cornell and provided courtesy NASA/JPL-Caltech.

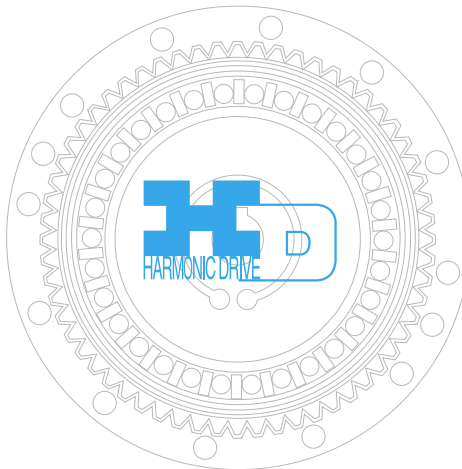

Glass and Ceramic Manufacturing Systems



Robots



Humanoid Robots

Source: Honda Motor Co., Ltd.



Printing, Bookbinding and Paper Machines

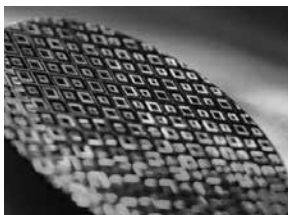

Semiconductor Manufacturing Equip.



Optical Equipment



Machine Tools



Paper-making Machines



Flat Panel Display Manufacturing Equip.

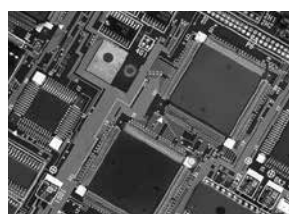

Printed Circuit Board Manufacturing Machines



Aerospace

Experts in Precision Motion Control

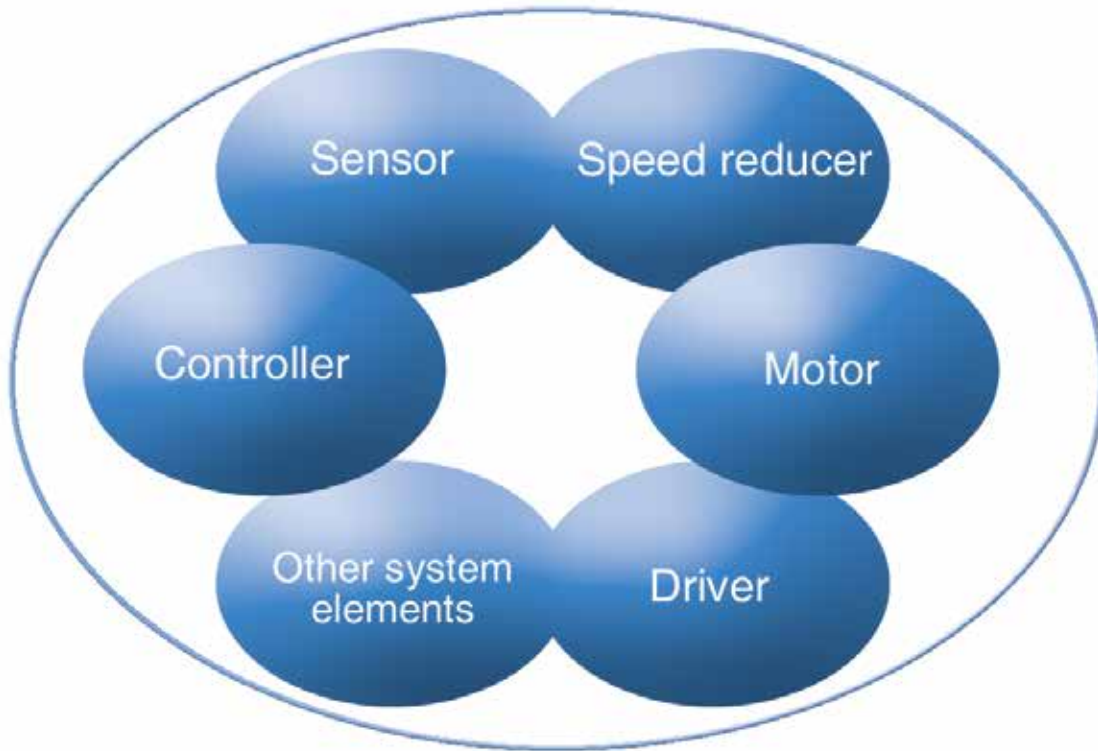

Other Products

HarmonicDrive® Gearing

HarmonicDrive® speed reducer delivers precise motion control by utilizing the strain wave gearing principle.

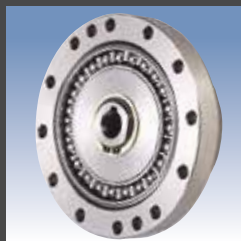

Rotary Actuators

High-torque actuators combine performance matched servomotors with HarmonicDrive® gears to deliver excellent dynamic control characteristics.

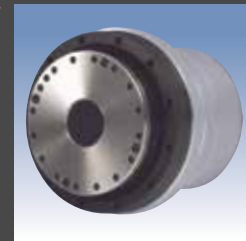

Linear Actuators

Compact linear actuators combine a precision lead screw and HarmonicDrive® gear. Our versatile actuators deliver both ultra precise positioning and high torque.



CSF Mini Gearheads

CSF mini gearheads provide high positioning accuracy in a super-compact package.



Harmonic Drive LLC

Boston US Headquarters

247 Lynnfield Street
Peabody, MA 01960

New York Sales Office

100 Motor Parkway
Suite 116
Hauppauge, NY 11788

California Sales Office

333 W. San Carlos Street
Suite 1070
San Jose, CA 95110

Chicago Sales Office

137 N. Oak Park Ave., Suite 410
Oak Park, IL 60301

T: 800.921.3332

T: 978.532.1800

F: 978.532.9406

www.HarmonicDrive.net

Group Companies

Harmonic Drive Systems, Inc.
6-25-3 Minami-Ohi, Shinagawa-ku
Tokyo 141-0013, Japan

Harmonic Drive AG
Hoenbergstrasse, 14, D-6555
Limburg/Lahn Germany

Harmonic Drive®, Harmonic Gearhead®, Harmonic Planetary® and Quick Connect® are registered trademarks of Harmonic Drive LLC. All other trademarks are property of their respective owners.

