

HarmonicPlanetary[®] HPN Value Series

Size

11, 14, 20, 32, 40

5
Sizes

Peak Torque

9Nm ~ 752Nm

Reduction Ratio

Single stage: 3:1 to 10:1, Two stage: 15:1 to 50:1

Backlash

Single stage: < 5 arc-min, Two stage: < 7 arc-min

High Efficiency

Up to 97%

Output Bearing

Output shaft supported by dual radial ball bearing system. The two bearings straddle the planet carrier maximizing tilting moment capacity.

Easy mounting to a wide variety of servomotors

Quick Connect[®] motor adaptation system includes a clamshell style servo coupling and piloted adapter flange.



CONTENTS

| | |
|----------------------------------|-------|
| Rating Table | 65 |
| Performance Table | 66 |
| Outline Dimensions | 67-71 |
| Product Sizing & Selection | 72-73 |

HPN - 14 | A - 05 - Z - J6 - Motor Code

| Model Name | Size | Design Revision | Reduction Ratio | Input Side Bearing | Output Configuration | Input Configuration |
|--|------|-----------------|---|--|--|---|
| HarmonicPlanetary [®] HPN High Torque | 11 | A | 4, 5, 7, 10, 15, 20, 25, 30, 35, 40, 45, 50 | Z: Input side bearing with double non-contact shields D: Input side bearing with double contact seals. (Recommended for output shaft up orientation.) | J6: Shaft output with key and center tapped hole J8: Shaft output with center tapped hole | This code represents the motor mounting configuration. Please contact us for a unique part number based on the motor you are using. |
| | 14 | | | | | |
| | 20 | | | | | |
| | 32 | | | | | |
| | 40 | | | | | |

Gearhead Construction

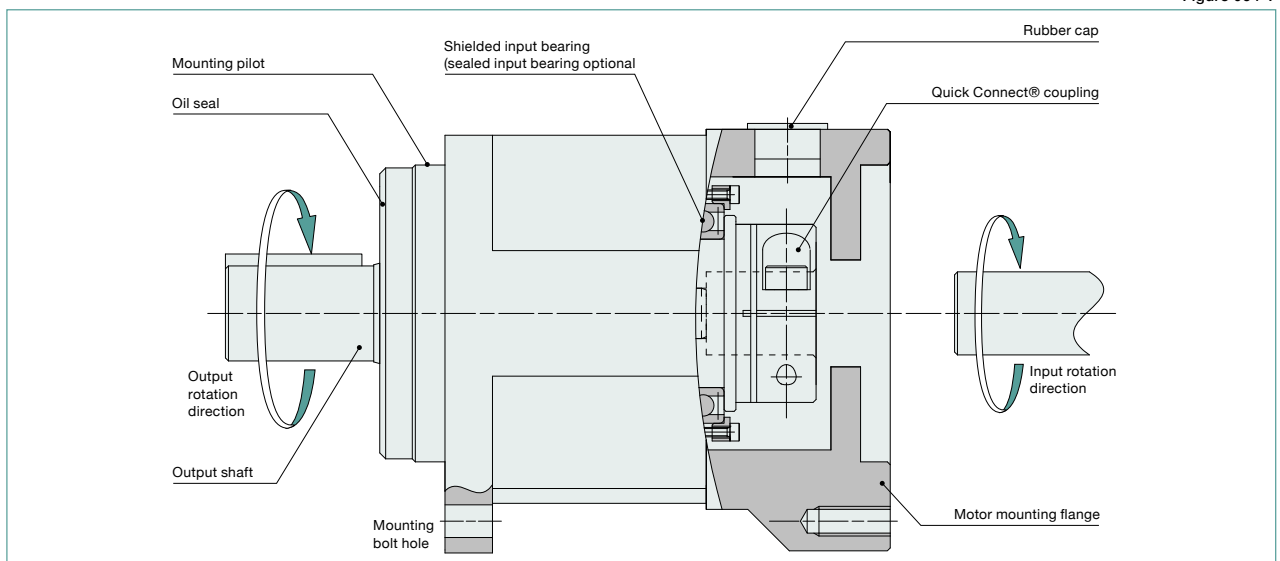

Figure 064-1

Rating Table

Table 065-1

| Size | Number of Stages | Ratio | Rated Torque L10 *1 | Rated Torque L50 *1 | Limit for Repeated Peak Torque *2 | Limit for Momentary Torque *3 | Max. Average Input Speed*4 | Max. Input Speed*5 | Allowable Radial Load*6 | Allowable Axial Load*7 | | | | | | |
|------|------------------|-------|---------------------|---------------------|-----------------------------------|-------------------------------|----------------------------|--------------------|-------------------------|------------------------|-------|-------|-------|-------|-------|-------|
| | | | Nm | Nm | Nm | Nm | rpm | rpm | N | N | | | | | | |
| 11 | 1 | 4 | 9 | 14 | 14 | 40 | 3,000 | 10,000 | 480 | 640 | | | | | | |
| | | 5 | 9 | 14 | 16 | 40 | | | | | | | | | | |
| | | 7 | 8 | 11 | 11 | 40 | | | | | | | | | | |
| | | 10 | 7 | 9 | 9 | 40 | | | | | | | | | | |
| | 2 | 15 | 11 | 18 | 24 | 40 | | | | | | | | | | |
| | | 20 | 13 | 22 | 24 | 40 | | | | | | | | | | |
| | | 25 | 13 | 20 | 24 | 40 | | | | | | | | | | |
| | | 30 | 15 | 25 | 26 | 40 | | | | | | | | | | |
| | | 35 | 16 | 26 | 26 | 40 | | | | | | | | | | |
| | | 40 | 17 | 26 | 26 | 40 | | | | | | | | | | |
| | | 45 | 17 | 26 | 26 | 40 | | | | | | | | | | |
| | | 50 | 18 | 26 | 26 | 40 | | | | | | | | | | |
| | | 14 | 1 | 3 | 14 | 22 | | | | | 25 | 89 | 3,000 | 6,000 | 840 | 900 |
| | | | | 4 | 18 | 28 | | | | | 50 | 110 | | | | |
| 5 | 18 | | | 29 | 50 | 107 | | | | | | | | | | |
| 7 | 20 | | | 30 | 37 | 100 | | | | | | | | | | |
| 10 | 14 | | | 18 | 18 | 79 | | | | | | | | | | |
| 2 | 15 | | 21 | 30 | 43 | 97 | | | | | | | | | | |
| | 20 | | 23 | 30 | 49 | 100 | | | | | | | | | | |
| | 25 | | 26 | 30 | 38 | 102 | | | | | | | | | | |
| | 30 | | 26 | 40 | 48 | 98 | | | | | | | | | | |
| | 35 | | 28 | 40 | 49 | 99 | | | | | | | | | | |
| | 40 | | 29 | 30 | 38 | 100 | | | | | | | | | | |
| | 45 | | 29 | 30 | 38 | 100 | | | | | | | | | | |
| | 50 | | 20 | 26 | 26 | 94 | | | | | | | | | | |
| | 20 | | 1 | 3 | 31 | 51 | 74 | 226 | 3,000 | 6,000 | 1,800 | 2,200 | | | | |
| 4 | | 50 | | 80 | 130 | 256 | | | | | | | | | | |
| 5 | | 52 | | 80 | 149 | 256 | | | | | | | | | | |
| 7 | | 55 | | 80 | 113 | 256 | | | | | | | | | | |
| 10 | | 41 | | 54 | 54 | 216 | | | | | | | | | | |
| 2 | | 15 | 59 | 80 | 129 | 256 | | | | | | | | | | |
| | | 20 | 66 | 80 | 147 | 256 | | | | | | | | | | |
| | | 25 | 72 | 80 | 114 | 256 | | | | | | | | | | |
| | | 30 | 72 | 80 | 139 | 250 | | | | | | | | | | |
| | | 35 | 79 | 80 | 112 | 256 | | | | | | | | | | |
| | | 40 | 80 | 80 | 112 | 256 | | | | | | | | | | |
| | | 45 | 80 | 80 | 112 | 256 | | | | | | | | | | |
| | | 50 | 58 | 75 | 75 | 216 | | | | | | | | | | |
| | | 32 | 1 | 3 | 94 | 153 | 254 | 625 | | | | | 3,000 | 6,000 | 3,900 | 3,800 |
| 4 | 122 | | | 198 | 376 | 625 | | | | | | | | | | |
| 5 | 127 | | | 200 | 376 | 625 | | | | | | | | | | |
| 7 | 135 | | | 200 | 376 | 625 | | | | | | | | | | |
| 10 | 128 | | | 185 | 185 | 625 | | | | | | | | | | |
| 2 | 15 | | 146 | 200 | 376 | 625 | | | | | | | | | | |
| | 20 | | 162 | 200 | 376 | 625 | | | | | | | | | | |
| | 25 | | 176 | 200 | 376 | 625 | | | | | | | | | | |
| | 30 | | 179 | 250 | 376 | 625 | | | | | | | | | | |
| | 35 | | 193 | 250 | 376 | 625 | | | | | | | | | | |
| | 40 | | 200 | 300 | 376 | 625 | | | | | | | | | | |
| | 45 | | 206 | 300 | 376 | 625 | | | | | | | | | | |
| | 50 | | 193 | 251 | 251 | 625 | | | | | | | | | | |
| | 40 | | 1 | 3 | 272 | 440 | 752 | 1137 | 3,000 | 6,000 | 5,500 | 5,400 | | | | |
| 4 | | 287 | | 460 | 752 | 1265 | | | | | | | | | | |
| 5 | | 298 | | 480 | 752 | 1265 | | | | | | | | | | |
| 7 | | 317 | | 510 | 752 | 829 | | | | | | | | | | |
| 10 | | 302 | | 480 | 509 | 829 | | | | | | | | | | |
| 2 | | 15 | 342 | 530 | 752 | 1265 | | | | | | | | | | |
| | | 20 | 380 | 600 | 752 | 1265 | | | | | | | | | | |
| | | 25 | 413 | 650 | 752 | 1127 | | | | | | | | | | |
| | | 30 | 421 | 650 | 752 | 1265 | | | | | | | | | | |
| | | 35 | 452 | 700 | 752 | 1127 | | | | | | | | | | |
| | | 40 | 468 | 700 | 752 | 1127 | | | | | | | | | | |
| | | 45 | 484 | 700 | 752 | 1127 | | | | | | | | | | |
| | | 50 | 432 | 562 | 562 | 1162 | | | | | | | | | | |

*1: Rated torque is based on life of 20,000 hours at max average input speed.

*2: The limit for torque during start and stop cycles.

*3: The limit for torque during emergency stops or from external shock loads. Always operate below this value.

*4: Max value of average input rotational speed during operation.

*5: Maximum instantaneous input speed.

*6: The load at which the output bearing will have 20,000 hour life at 100 rpm output speed (Axial load = 0 and radial load point is in the center of the output shaft)

*7: The load at which the output bearing will have 20,000 hour life at 100 rpm output speed (Radial load = 0 and axial load point is in the center of the output shaft)

Performance

Table 065-2

| Size | Number of Stages | Ratio | Backlash | Noise*1 | Torsional Stiffness | |
|------|------------------|-------|----------|---------|---------------------|-------------|
| | | | arc min | dB | kgfm/arc-min | X100N·m/rad |
| 11 | 1 | 4 | < 5 | < 56 | 0.060 | 20 |
| | | 5 | | | | |
| | | 7 | | | | |
| | | 10 | | | | |
| | 2 | 15 | < 7 | | | |
| | | 20 | | | | |
| | | 25 | | | | |
| | | 30 | | | | |
| | | 35 | | | | |
| | | 40 | | | | |
| 14 | 1 | 3 | < 5 | < 58 | 0.27 | 93 |
| | | 4 | | | | |
| | | 5 | | | | |
| | | 7 | | | | |
| | 2 | 10 | < 7 | | | |
| | | 15 | | | | |
| | | 20 | | | | |
| | | 25 | | | | |
| | | 30 | | | | |
| | | 35 | | | | |
| 20 | 1 | 40 | < 5 | < 60 | 0.77 | 260 |
| | | 45 | | | | |
| | | 50 | | | | |
| | | 3 | | | | |
| | 2 | 4 | < 7 | | | |
| | | 5 | | | | |
| | | 7 | | | | |
| | | 10 | | | | |
| | | 15 | | | | |
| | | 20 | | | | |
| 32 | 1 | 25 | < 5 | < 63 | 2.8 | 940 |
| | | 30 | | | | |
| | | 35 | | | | |
| | | 40 | | | | |
| | 2 | 45 | < 7 | | | |
| | | 50 | | | | |
| | | 3 | | | | |
| | | 4 | | | | |
| | | 5 | | | | |
| | | 7 | | | | |
| 40 | 1 | 10 | < 5 | < 65 | 4.2 | 1430 |
| | | 15 | | | | |
| | | 20 | | | | |
| | | 25 | | | | |
| | 2 | 30 | < 7 | | | |
| | | 35 | | | | |
| | | 40 | | | | |
| | | 45 | | | | |
| | | 50 | | | | |
| | | 3 | | | | |

Table 065-3

| Size | Number of Stages | Ratio | Backlash | Noise*1 | Torsional Stiffness | |
|------|------------------|-------|----------|---------|---------------------|-------------|
| | | | arc min | dB | kgfm/arc-min | X100N·m/rad |
| 32 | 1 | 3 | < 5 | < 63 | 2.8 | 940 |
| | | 4 | | | | |
| | | 5 | | | | |
| | | 7 | | | | |
| | 2 | 10 | < 7 | | | |
| | | 15 | | | | |
| | | 20 | | | | |
| | | 25 | | | | |
| | | 30 | | | | |
| | | 35 | | | | |
| 40 | 1 | 40 | < 5 | < 65 | 4.2 | 1430 |
| | | 45 | | | | |
| | | 50 | | | | |
| | | 3 | | | | |
| | 2 | 4 | < 7 | | | |
| | | 5 | | | | |
| | | 7 | | | | |
| | | 10 | | | | |
| | | 15 | | | | |
| | | 20 | | | | |
| 40 | 1 | 25 | < 5 | < 65 | 4.2 | 1430 |
| | | 30 | | | | |
| | | 35 | | | | |
| | | 40 | | | | |
| | 2 | 45 | < 7 | | | |
| | | 50 | | | | |
| | | 3 | | | | |

*1: The above noise values are reference values.

HPN-11A Outline Dimensions

Figure 067-1
(Unit: mm)

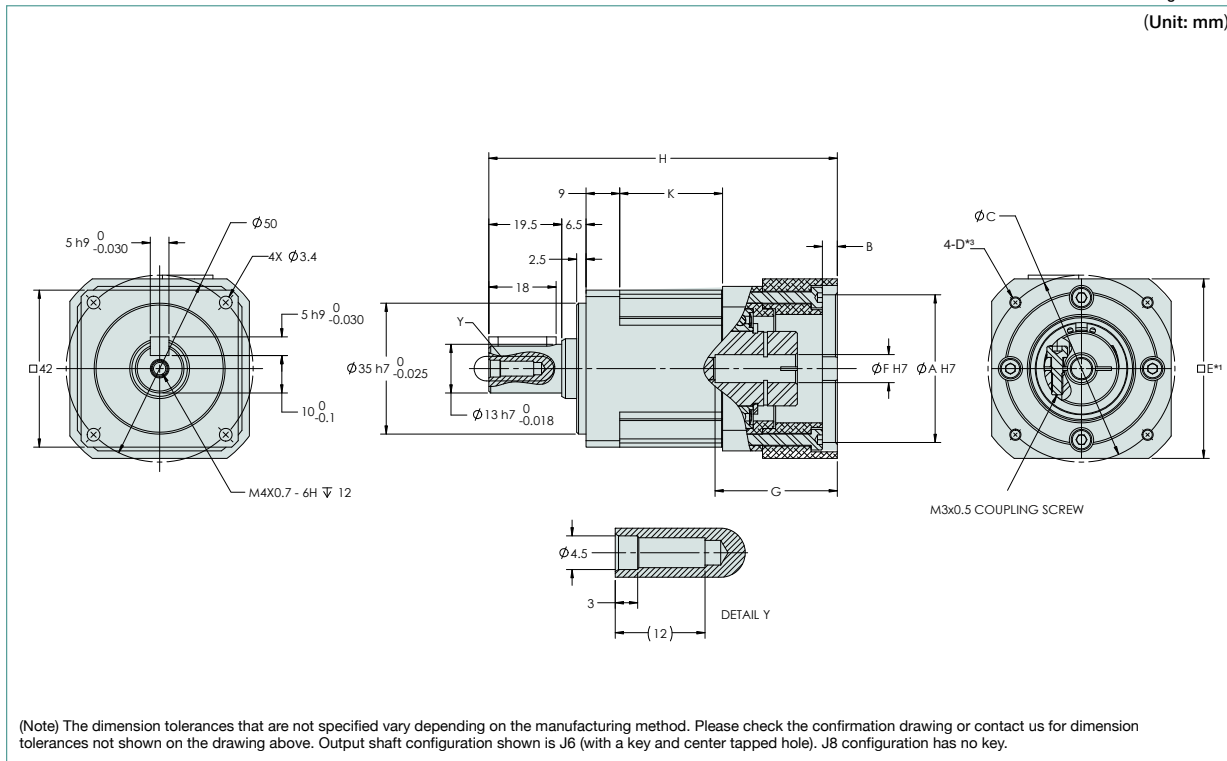

(Note) The dimension tolerances that are not specified vary depending on the manufacturing method. Please check the confirmation drawing or contact us for dimension tolerances not shown on the drawing above. Output shaft configuration shown is J6 (with a key and center tapped hole). J8 configuration has no key.

Dimension Table

(Unit: mm) Table 067-1

| | A (H7)*1 | | B*1 | C*1 | | F (H7)*1 | | G*1 | | H*1 | K | Mass(kg)*2 |
|--------------|----------|------|------|------|------|----------|------|------|------|------|------|------------|
| | Min. | Max. | Max. | Min. | Max. | Min. | Max. | Min. | Max. | | | |
| Single Stage | 20 | 55 | 3 | 30 | 75 | 5 | 9 | 18 | 29 | 93.5 | 27.5 | 0.44 |
| Two Stage | | | | | | | | | | 113 | 47 | 0.57 |

Refer to the confirmation drawing for detailed dimensions. Dimensions of typical products are shown. Please contact us for other mounting options if the configurations shown above are not suitable for your particular motor.

- *1 May vary depending on motor interface dimensions.
- *2 The mass will vary slightly depending on the ratio and on the inside diameter of the input shaft coupling.
- *3 Tapped hole for motor mounting screw.

Moment of Inertia

(10⁻⁴ kgm²) Table 067-2

| HPN-11A | Ratio Coupling | 4 | 5 | 7 | 10 | 15 | 20 | 25 | 30 | 35 | 40 | 45 | 50 |
|---------|-------------------|---|------|------|------|------|------|------|------|------|------|------|------|
| | | 1 | 0.04 | 0.04 | 0.04 | 0.04 | 0.04 | 0.04 | 0.04 | 0.04 | 0.04 | 0.04 | 0.04 |

HPN-14A Outline Dimensions

Figure 068-1
(Unit: mm)

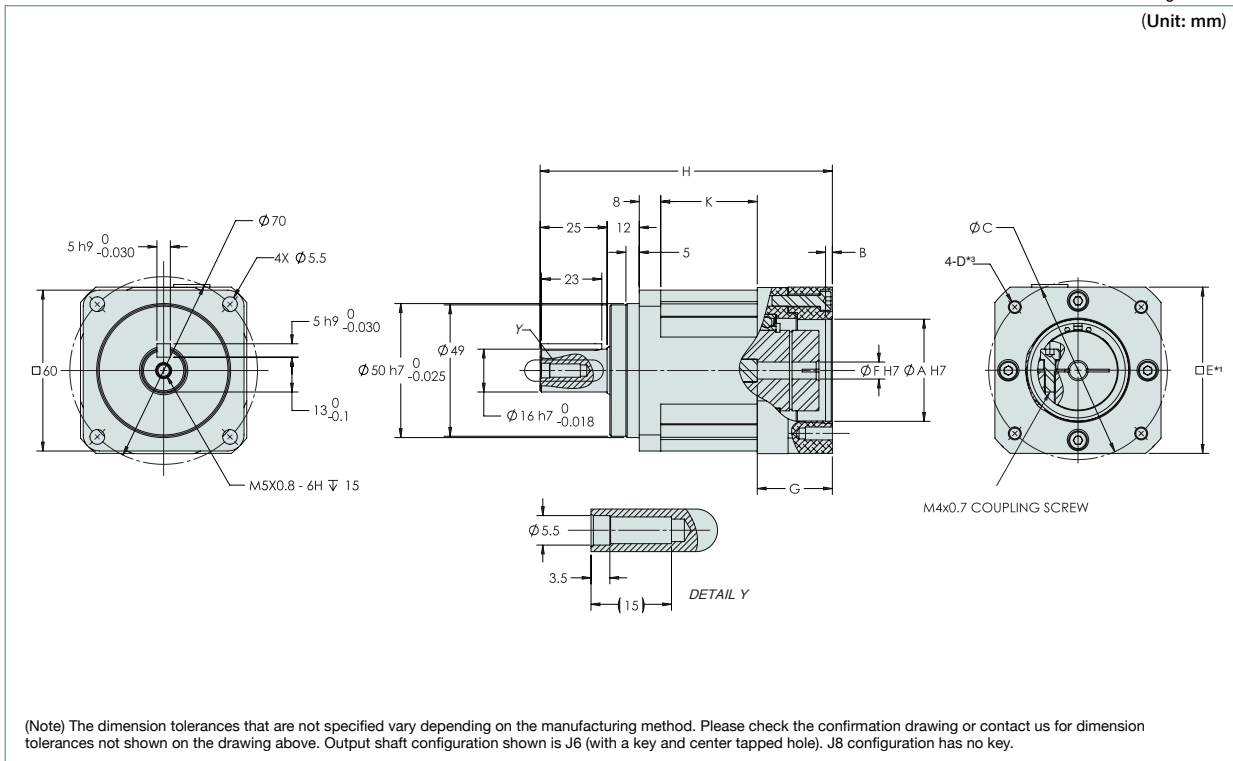

(Note) The dimension tolerances that are not specified vary depending on the manufacturing method. Please check the confirmation drawing or contact us for dimension tolerances not shown on the drawing above. Output shaft configuration shown is J6 (with a key and center tapped hole). J8 configuration has no key.

Dimension Table

(Unit: mm) Table 068-1

| | Flange | Coupling | A (H7) ^{*1} | | B ^{*1} | C ^{*1} | | F (H7) ^{*1} | | G ^{*1} | | H ^{*1} | K | Mass(kg) ^{*2} |
|--------------|--------|----------|----------------------|------|-----------------|-----------------|------|----------------------|------|-----------------|------|-----------------|----|------------------------|
| | | | Min. | Max. | Max. | Min. | Max. | Min. | Max. | Min. | Max. | | | |
| Single Stage | 3 | 3 | 35 | 75 | 5 | 40 | 100 | 6 | 14 | 18 | 28 | 117 | 36 | 0.95 |
| Two Stage | | | | | | | | | | | | 142 | 61 | 1.3 |

Refer to the confirmation drawing for detailed dimensions. Dimensions of typical products are shown. Please contact us for other mounting options if the configurations shown above are not suitable for your particular motor.

^{*1} May vary depending on motor interface dimensions.

^{*2} The mass will vary slightly depending on the ratio and on the inside diameter of the input shaft coupling.

^{*3} Tapped hole for motor mounting screw.

Moment of Inertia

(10⁻⁴ kgm²) Table 068-2

| HPN-14A | Ratio Coupling | 3 | 4 | 5 | 7 | 10 | 15 | 20 | 25 | 30 | 35 | 40 | 45 | 50 |
|---------|-------------------|---|------|------|------|------|------|------|------|------|------|------|------|------|
| | | 1 | 0.26 | 0.23 | 0.21 | 0.20 | 0.20 | 0.20 | 0.20 | 0.20 | 0.20 | 0.19 | 0.19 | 0.19 |

HPN-20A Outline Dimensions

Figure 069-1

(Unit: mm)

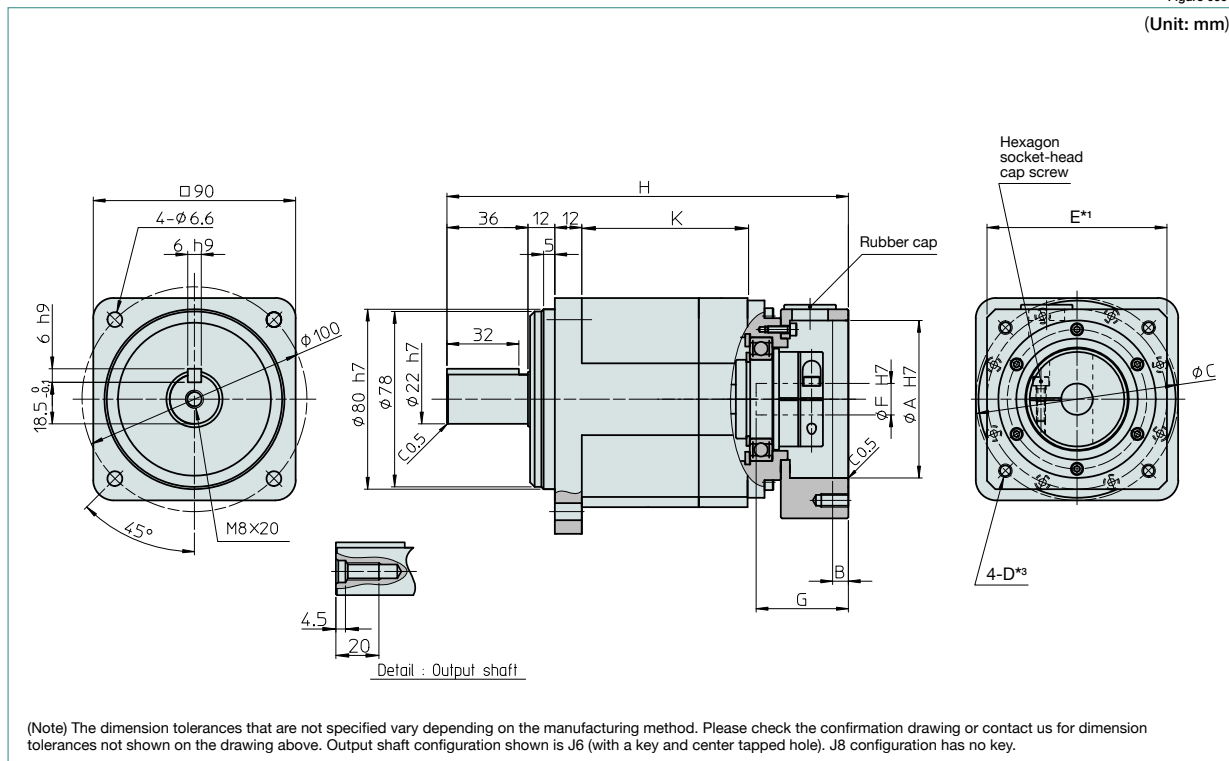

(Note) The dimension tolerances that are not specified vary depending on the manufacturing method. Please check the confirmation drawing or contact us for dimension tolerances not shown on the drawing above. Output shaft configuration shown is J6 (with a key and center tapped hole). J8 configuration has no key.

Dimension Table

(Unit: mm) Table 069-1

| | Flange | Coupling | A (H7)*1 | | B** | C*1 | | F (H7)*1 | | G*1 | | H*1 | K | Mass(kg)*2 |
|--------------|--------|----------|----------|------|------|------|------|----------|------|------|------|-------|----|------------|
| | | | Min. | Max. | Max. | Min. | Max. | Min. | Max. | Min. | Max. | | | |
| Single Stage | 1 | 1 | 50 | 85 | 7 | 55 | 115 | 13.5 | 25.4 | 26 | 47 | 166.5 | 52 | 3 |
| Two Stage | | | | | | | | | | 24.5 | 41 | | | |
| Single Stage | 2 | 1 | 50 | 125 | 7 | 60 | 155 | 13.5 | 25.4 | 44 | 65 | 184.5 | 52 | 3.7 |
| Two Stage | | | | | | | | | | 42.5 | 59 | | | |
| Single Stage | 3 | 2 | 35 | 75 | 7 | 40 | 100 | 9.5 | 14.2 | 25.5 | 40.5 | 160 | 52 | 2.6 |
| Two Stage | | | | | | | | | | 4 | 3 | | | |

Refer to the confirmation drawing for detailed dimensions. Dimensions of typical products are shown. Please contact us for other mounting options if the configurations shown above are not suitable for your particular motor.

*1 May vary depending on motor interface dimensions.

*2 The mass will vary slightly depending on the ratio and on the inside diameter of the input shaft coupling.

*3 Tapped hole for motor mounting screw.

Moment of Inertia

(10⁻⁴ kgm²) Table 069-2

| HPN-20A | Ratio | 3 | 4 | 5 | 7 | 10 | 15 | 20 | 25 | 30 | 35 | 40 | 45 | 50 |
|---------|----------|------|------|------|------|------|------|------|------|------|------|------|------|------|
| | Coupling | 1.20 | 1.00 | 0.92 | 0.87 | 0.86 | 0.86 | 0.87 | 0.87 | 0.85 | 0.86 | 0.85 | 0.85 | 0.85 |
| | 1 | 1.20 | 1.00 | 0.92 | 0.87 | 0.86 | 0.86 | 0.87 | 0.87 | 0.85 | 0.86 | 0.85 | 0.85 | 0.85 |
| | 2 | 0.53 | 0.36 | 0.29 | 0.24 | 0.21 | - | - | - | - | - | - | - | - |
| | 3 | - | - | - | - | - | 0.23 | 0.22 | 0.22 | 0.20 | 0.21 | 0.20 | 0.20 | 0.20 |

HPN-32A Outline Dimensions

Figure 070-1
(Unit: mm)

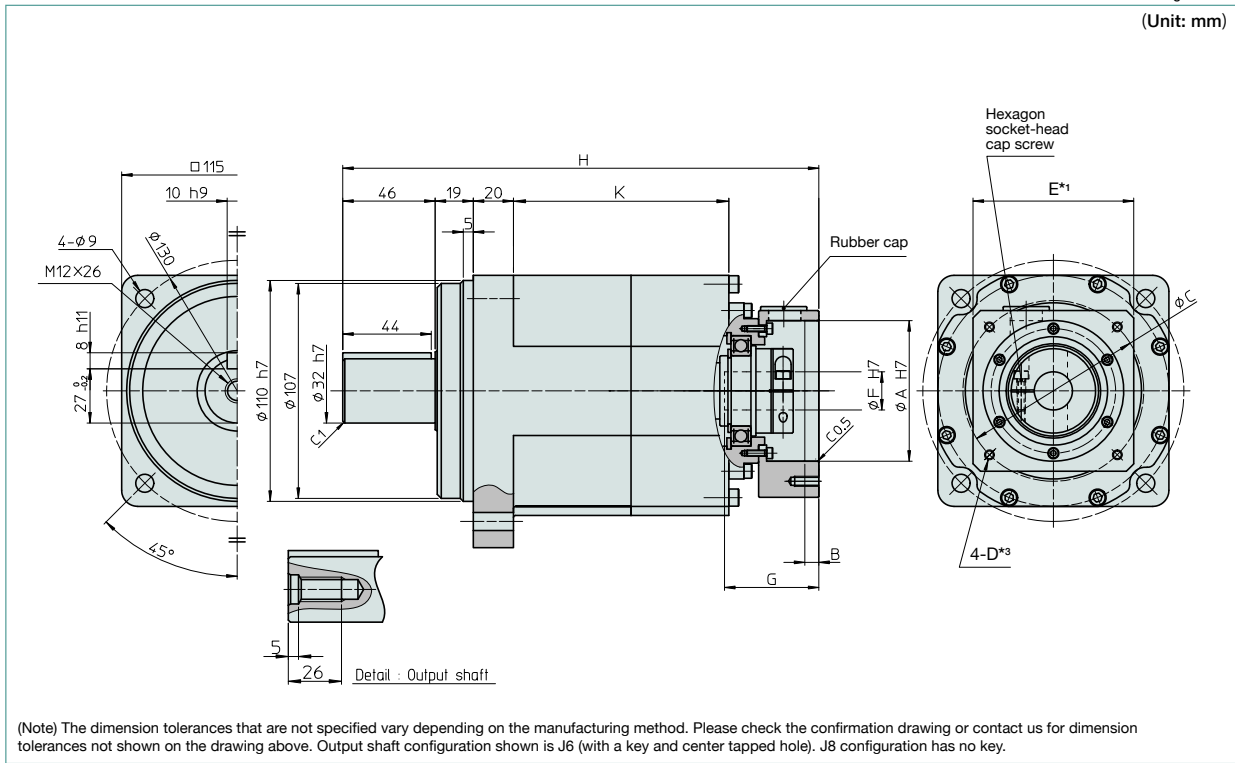

(Note) The dimension tolerances that are not specified vary depending on the manufacturing method. Please check the confirmation drawing or contact us for dimension tolerances not shown on the drawing above. Output shaft configuration shown is J6 (with a key and center tapped hole). J8 configuration has no key.

Dimension Table

(Unit: mm) Table 070-1

| | Flange | Coupling | A (H7) ^{*1} | | B ^{*1} | C ^{*1} | | F (H7) ^{*1} | | G ^{*1} | | H ^{*1} | K | Mass(kg) ^{*2} |
|--------------|--------|----------|----------------------|------|-----------------|-----------------|------|----------------------|------|-----------------|------|-----------------|-------|------------------------|
| | | | Min. | Max. | Max. | Min. | Max. | Min. | Max. | Min. | Max. | | | |
| Single Stage | 1 | 1 | 50 | 85 | 7 | 55 | 115 | 13.5 | 25.4 | 25 | 51 | 200 | 58.5 | 6.6 |
| | 2 | 2 | 55 | 125 | 7 | 65 | 155 | 15.5 | 28 | 42 | 64 | 217.5 | 58.5 | 7.7 |
| | 3 | 3 | 65 | 215 | 6.5 | 75 | 260 | 21.5 | 41 | 47 | 85 | 238.5 | 58.5 | 9.3 |
| Two Stage | 4 | 4 | 50 | 85 | 7 | 55 | 115 | 13.5 | 25.4 | 26 | 46.5 | 246.5 | 107.2 | 7.9 |
| | 5 | 4 | 50 | 125 | 7 | 60 | 155 | 13.5 | 25.4 | 44 | 65 | 264.5 | 107.2 | 9.1 |
| | 6 | 5 | 35 | 75 | 7 | 40 | 100 | 9.5 | 14.2 | 25.5 | 40.5 | 240.5 | 107.2 | 7.2 |

Refer to the confirmation drawing for detailed dimensions. Dimensions of typical products are shown. Please contact us for other mounting options if the configurations shown above are not suitable for your particular motor.

^{*1} May vary depending on motor interface dimensions.

^{*2} The mass will vary slightly depending on the ratio and on the inside diameter of the input shaft coupling.

^{*3} Tapped hole for motor mounting screw.

Moment of Inertia

(10⁻⁴ kgm²) Table 070-2

| HPN-32A | Ratio | 3 | 4 | 5 | 7 | 10 | 15 | 20 | 25 | 30 | 35 | 40 | 45 | 50 |
|---------|----------|-----|-----|-----|-----|------|------|------|------|------|------|------|------|----|
| | Coupling | 2.3 | 1.7 | 1.5 | 1.3 | 1.2 | - | - | - | - | - | - | - | - |
| 1 | 2.3 | 1.7 | 1.5 | 1.3 | 1.2 | - | - | - | - | - | - | - | - | - |
| 2 | 4.9 | 3.6 | 3.1 | 2.7 | 2.5 | - | - | - | - | - | - | - | - | - |
| 3 | 6.9 | 5.7 | 5.2 | 4.8 | 4.7 | - | - | - | - | - | - | - | - | - |
| 4 | - | - | - | - | - | 1.1 | 1.0 | 1.0 | 0.91 | 0.93 | 0.91 | 0.89 | 0.91 | - |
| 5 | - | - | - | - | - | 0.48 | 0.40 | 0.42 | 0.28 | 0.30 | 0.28 | 0.25 | 0.25 | - |

HPN-40A Outline Dimensions

Figure 071-1
(Unit: mm)

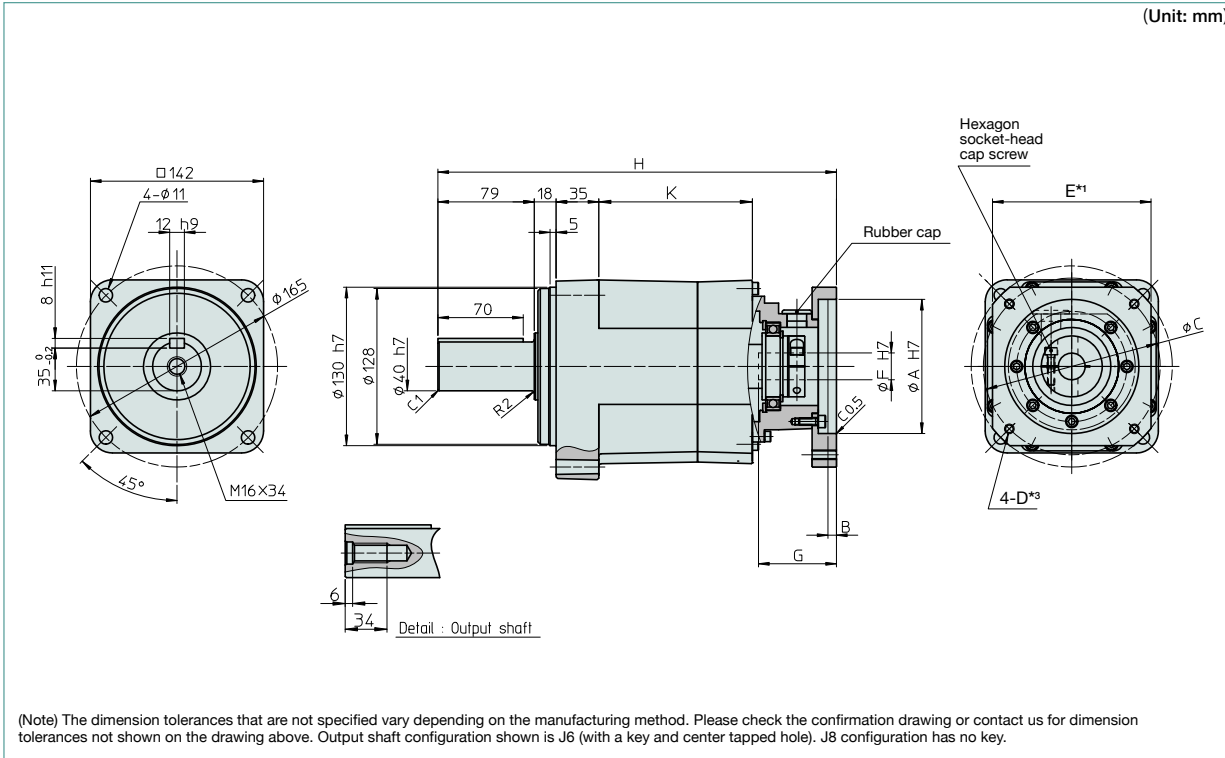

(Note) The dimension tolerances that are not specified vary depending on the manufacturing method. Please check the confirmation drawing or contact us for dimension tolerances not shown on the drawing above. Output shaft configuration shown is J6 (with a key and center tapped hole). J8 configuration has no key.

Dimension Table

(Unit: mm) Table 071-1

| | Flange | Coupling | A (H7)*1 | | B*1 | C*1 | | F (H7)*1 | | G*1 | | H*1 | K | Mass(kg)*2 |
|--------------|--------|----------|----------|------|------|------|------|----------|------|------|-------|-------|-----|------------|
| | | | Min. | Max. | Max. | Min. | Max. | Min. | Max. | Min. | Max. | | | |
| Single Stage | 1 | 1 | 70 | 215 | 6.5 | 80 | 260 | 27.5 | 41 | 34.5 | 71.5 | 295.5 | 81 | 17 |
| | 2 | 2 | 70 | 175 | 6.5 | 80 | 225 | 42 | 42 | 39 | 104.5 | 328.5 | 81 | 16 |
| | 3 | 3 | 70 | 125 | 7 | 80 | 155 | 15.5 | 18.5 | 42 | 71.5 | 295.5 | 81 | 13 |
| Two Stage | 4 | 4 | 55 | 125 | 7 | 65 | 155 | 15.5 | 28.5 | 42 | 63.5 | 332 | 126 | 17 |
| | 5 | 5 | 65 | 215 | 6.5 | 75 | 260 | 21.5 | 41 | 47 | 84.5 | 353 | 126 | 18 |

Refer to the confirmation drawing for detailed dimensions. Dimensions of typical products are shown. Please contact us for other mounting options if the configurations shown above are not suitable for your particular motor.

*1 May vary depending on motor interface dimensions.

*2 The mass will vary slightly depending on the ratio and on the inside diameter of the input shaft coupling.

*3 Tapped hole for motor mounting screw.

Moment of Inertia

(10⁴ kgm²) Table 071-2

| HPN-40A | Ratio | 3 | 4 | 5 | 7 | 10 | 15 | 20 | 25 | 30 | 35 | 40 | 45 | 50 |
|---------|----------|------|------|-----|-----|-----|-----|-----|-----|-----|-----|-----|-----|-----|
| | Coupling | | | | | | | | | | | | | |
| | 1 | 13.6 | 8.8 | 7.0 | 5.9 | 5.1 | - | - | - | - | - | - | - | - |
| | 2 | 15.8 | 11.0 | 9.2 | 7.7 | 6.9 | - | - | - | - | - | - | - | - |
| | 3 | 12.2 | 7.4 | 5.6 | 4.1 | 3.3 | - | - | - | - | - | - | - | - |
| | 4 | - | - | - | - | - | 3.9 | 3.6 | 3.8 | 2.8 | 3.0 | 2.9 | 2.8 | 2.8 |
| | 5 | - | - | - | - | - | 5.9 | 5.6 | 5.9 | 4.9 | 5.3 | 5.1 | 5.0 | 4.9 |

Sizing & Selection

To fully utilize the excellent performance of the HPN HarmonicPlanetary® gearheads, check your operating conditions and, using the flowchart, select the appropriate size gear for your application.

Check your operating conditions against the following application motion profile and select a suitable size based on the flowchart shown on the right. Also, compare any application radial and axial loads supported by the gearhead output shaft to the allowable values in the ratings table to ensure an adequate output bearing service life.

Application motion profile

Review the application motion profile. Check the specifications shown in the figure below.

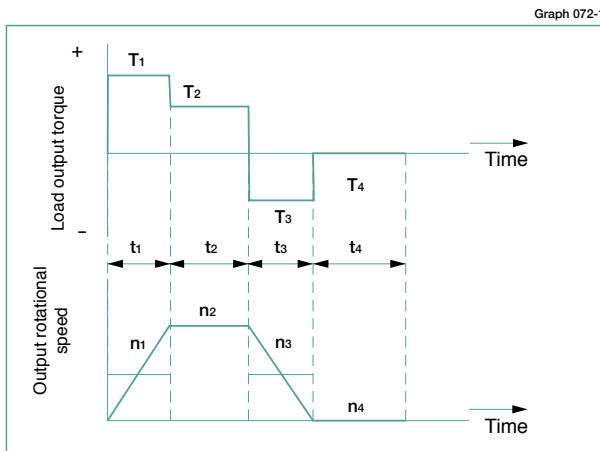

| | |
|---|---|
| Obtain the value of each application motion profile | |
| Load torque | T ₁ to T _n (Nm) |
| Time | t ₁ to t _n (sec) |
| Output rotational speed | n ₁ to n _n (rpm) |
| Normal operation pattern | |
| Starting (Acceleration) | T ₁ , t ₁ , n ₁ |
| Steady operation (constant velocity) | T ₂ , t ₂ , n ₂ |
| Stopping (deceleration) | T ₃ , t ₃ , n ₃ |
| Dwell | T ₄ , t ₄ , n ₄ |
| Maximum rotational speed | |
| Max. output rotational speed | n _{0 max} ≥ n ₁ to n _n |
| Max. input rotational speed (Restricted by motors) | n _{i max} n ₁ ×R to n _n ×R |
| | R: Reduction ratio |
| Emergency stop torque | |
| When impact torque is applied | T _s |
| Required life | L ₁₀ = L (hours) |

Flowchart for selecting a size

Please use the flowchart shown below for selecting a size. Operating conditions must not exceed the performance ratings.

Calculate the average load torque applied on the output side from the application motion profile: T_{av} (Nm).

$$T_{av} = \sqrt[10/3]{\frac{|n_1 \cdot t_1 \cdot |T_1|^{10/3} + |n_2 \cdot t_2 \cdot |T_2|^{10/3} + \dots + |n_n \cdot t_n \cdot |T_n|^{10/3}|}{n_1 \cdot t_1 + n_2 \cdot t_2 + \dots + n_n \cdot t_n}}$$

Calculate the average output speed based on the application motion profile: n_{o av} (rpm)

$$n_{o av} = \frac{|n_1 \cdot t_1 + n_2 \cdot t_2 + \dots + n_n \cdot t_n|}{t_1 + t_2 + \dots + t_n}$$

Make a preliminary model selection with the following condition: T_{av} ≤ Average load torque (Refer to rating table).

● NG

OK

Determine the reduction ratio (R) based on the maximum output rotational speed (n_{o max}) and maximum input rotational speed (n_{i max}).

$$\frac{n_{i max}}{n_{o max}} \geq R$$

(A limit is placed on n_{i max} by motors.)
Calculate the maximum input speed (n_{i max}) from the maximum output speed (n_{o max}) and the reduction ratio (R).
n_{i max} = n_{o max} · R

Calculate the average input speed (n_{i av}) from the average output speed (n_{o av}) and the reduction ratio (R): n_{i av} = n_{o av} · R ≤ Max. average input speed (n_r).

● NG

OK

Check whether the maximum input speed is equal to or less than the values in the rating table.
n_{i max} ≤ maximum input speed (rpm)

● NG

OK

Check whether T₁ and T₃ are within the limit for repeated peak torques (Nm) on start and stop in the rating table.

● NG

OK

Check whether T_s is less than the limit for momentary peak torque (Nm) value from the ratings.

● NG

Calculate the life and check whether it meets the specification requirement.

T_r: Rated torque
n_r: Max. average input speed

$$L_{10} = 20,000 \cdot \left(\frac{T_r}{T_{av}}\right)^{10/3} \cdot \left(\frac{n_r}{n_{i av}}\right) \text{ (Hour)}$$

● NG

OK

The model number is confirmed.

Refer to the Caution note below.

Review the operation conditions, size and reduction ratio.

Caution

If any of the following conditions exist, please consider selecting the next larger speed reducer, reduce the operating loads or reduce the operating speed. If this cannot be done, please contact Harmonic Drive LLC. Exercise caution especially when the duty cycle is close to continuous operation.

- i) Actual average load torque (T_{av}) > rated torque or
- ii) Actual average input rotational speed (n_{i av}) > max average input speed (n_r),
- iii) Gearhead housing temperature > 70°C.

Example of size selection

| | | |
|---|--|--|
| Load torque | T_n (Nm) | Maximum rotational speed Max. output rotational speed no max = 120 rpm Max. input rotational speed ni max = 5,000 rpm (Restricted by motors) |
| Time | t_n (sec) | |
| Output rotational speed | n_n (rpm) | |
| Normal operation pattern | | Emergency stop torque When impact torque is applied $T_s = 180$ Nm |
| Starting (acceleration) | $T_1 = 70$ Nm, $t_1 = 0.3$ sec, $n_1 = 60$ rpm | |
| Steady operation (constant velocity) | $T_2 = 18$ Nm, $t_2 = 3$ sec, $n_2 = 120$ rpm | |
| Stopping (deceleration) | $T_3 = 35$ Nm, $t_3 = 0.4$ sec, $n_3 = 60$ rpm | |
| Dwell | $T_4 = 0$ Nm, $t_4 = 5$ sec, $n_4 = 0$ rpm | |
| | | Required life $L_{50} = 30,000$ (hours) |

Calculate the average load torque applied to the output side based on the load torque pattern: T_{av} (Nm).

$$T_{av} = \sqrt[10/3]{\frac{|60\text{rpm}| \cdot 0.3\text{sec} \cdot |70\text{Nm}|^{10/3} + |120\text{rpm}| \cdot 3\text{sec} \cdot |18\text{Nm}|^{10/3} + |60\text{rpm}| \cdot 0.4\text{sec} \cdot |35\text{Nm}|^{10/3}}{|60\text{rpm}| \cdot 0.3\text{sec} + |120\text{rpm}| \cdot 3\text{sec} + |60\text{rpm}| \cdot 0.4\text{sec}}}$$

Calculate the average output speed based on the load torque pattern: no av (rpm)

$$no_{av} = \frac{|60\text{rpm}| \cdot 0.3\text{sec} + |120\text{rpm}| \cdot 3\text{sec} + |60\text{rpm}| \cdot 0.4\text{sec} + |0\text{rpm}| \cdot 5\text{sec}}{0.3\text{sec} + 3\text{sec} + 0.4\text{sec} + 5\text{sec}}$$

Make a preliminary model selection with the following conditions. $T_{av} = 30.2$ Nm \leq 80 Nm. (HPN-20A-30 is tentatively selected based on the average load torque (see the rating table) of size 20 and reduction ratio of 30.)

● NG

OK

Determine a reduction ratio (R) from the maximum output speed (no max) and maximum input speed (ni max).

$$\frac{5,000 \text{ rpm}}{120 \text{ rpm}} = 41.7 \geq 30$$

Calculate the maximum input speed (ni max) from the maximum output speed (no max) and reduction ratio (R): ni max = 120 rpm \cdot 30 = 3,720 rpm

Calculate the average input speed (ni av) from the average output speed (no av) and reduction ratio (R):
ni av = 46.2 rpm \cdot 30 = 1,386 rpm \leq Max average input speed of size 20 3,000 rpm

● NG

OK

Check whether the maximum input speed is less than the values specified in the rating table.
ni max = 3,720 rpm \leq 6,000 rpm (maximum input speed of size 20)

● NG

OK

Check whether T_1 and T_3 are within limit for repeated peak torque (Nm) on start and stop in the rating table.
 $T_1 = 70$ Nm \leq 139 Nm (Limit for repeated peak torque, size 20)
 $T_3 = 35$ Nm \leq 139 Nm (Limit for repeated peak torque, size 20)

● NG

OK

Check whether T_s is less than limit for momentary torque (Nm) in the rating table.
 $T_s = 180$ Nm \leq 256 Nm (momentary max. torque of size 20)

● NG

OK

Calculate life and check whether the calculated life meets the requirement.

$$L_{50} = 20,000 \cdot \left(\frac{80\text{Nm}}{30.2\text{Nm}}\right)^{10/3} \cdot \left(\frac{3,000\text{rpm}}{1,432\text{rpm}}\right) = 25,809,937 \text{ (hours)} \geq 30,000 \text{ (hours)}$$

● NG

OK

The selection of model number HPN-20A-30 is confirmed from the above calculations.

Refer to the Caution note at the bottom of page 72.

Review the operation conditions, size and reduction ratio.



Harmonic Planetary®

Harmonic Drive®

Technical Information

Efficiency 134

Output Bearing Specifications and 153
Checking Procedure

Input Bearing Specifications and 157
Checking Procedure

Product Handling

Assembly 159

Mechanical Tolerances 162

Lubrication 163

Warranty, Disposal 165

Safety 166

The rated value and performance vary depending on the product series.
Be sure to check the usage conditions and refer to the items conforming
to the related product.

Efficiency

In general, the efficiency of a speed reducer depends on the reduction ratio, input rotational speed, load torque, temperature and lubrication condition. The efficiency of each series under the following measurement conditions is plotted in the graphs on the next page. The values in the graph are average values.

Measurement condition

Table 134-1

| | |
|------------------------|---|
| Input rotational speed | HPGP / HPG / HPF / HPN: 3000rpm CSG-GH / CSF-GH: Indicated on each efficiency graph. |
| Ambient temperature | 25°C |
| Lubricant | Use standard lubricant for each model. (See pages 163- 164 for details.) |

Efficiency compensated for low temperature

Calculate the efficiency at an ambient temperature of 25°C or less by multiplying the efficiency at 25°C by the low-temperature efficiency correction value. Obtain values corresponding to an ambient temperature and to an input torque (TRi*) from the following graphs when calculating the low-temperature efficiency correction value.

HPGP

HPG

HPF

HPN

* TRi is an input torque corresponding to output torque at 25°C.

Graph 134-1

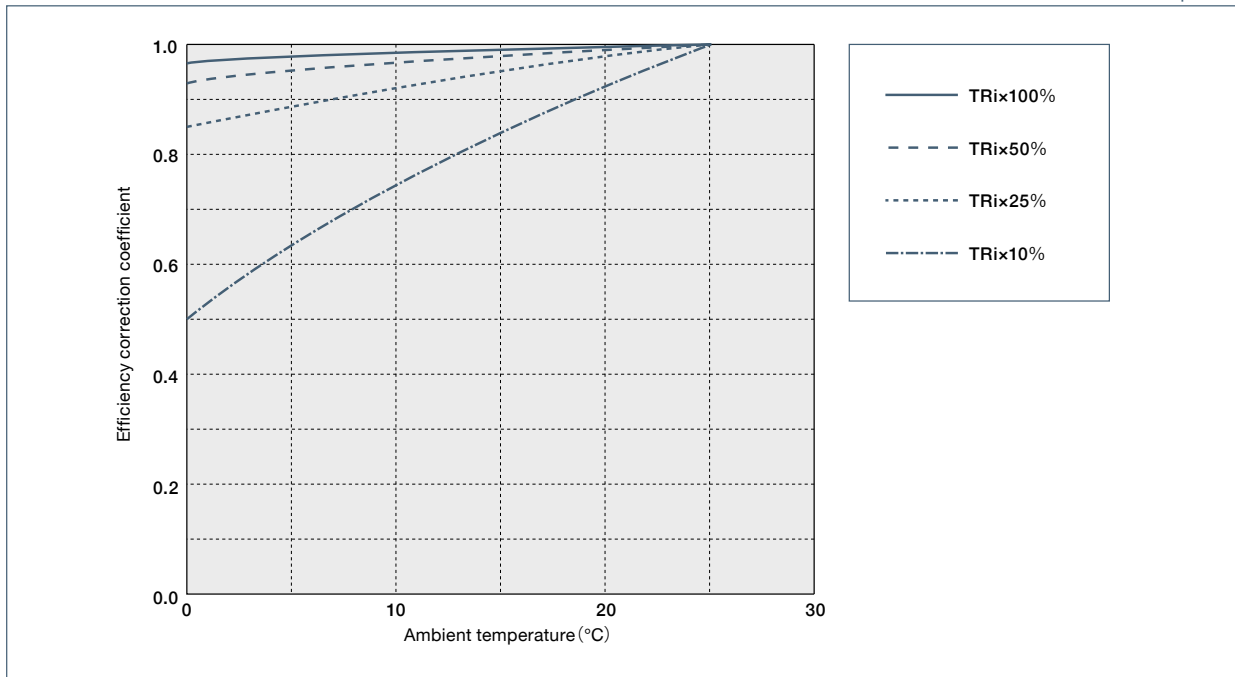

CSG-GH

CSF-GH

* TRi is an input torque corresponding to output torque at 25°C.

Graph 134-2

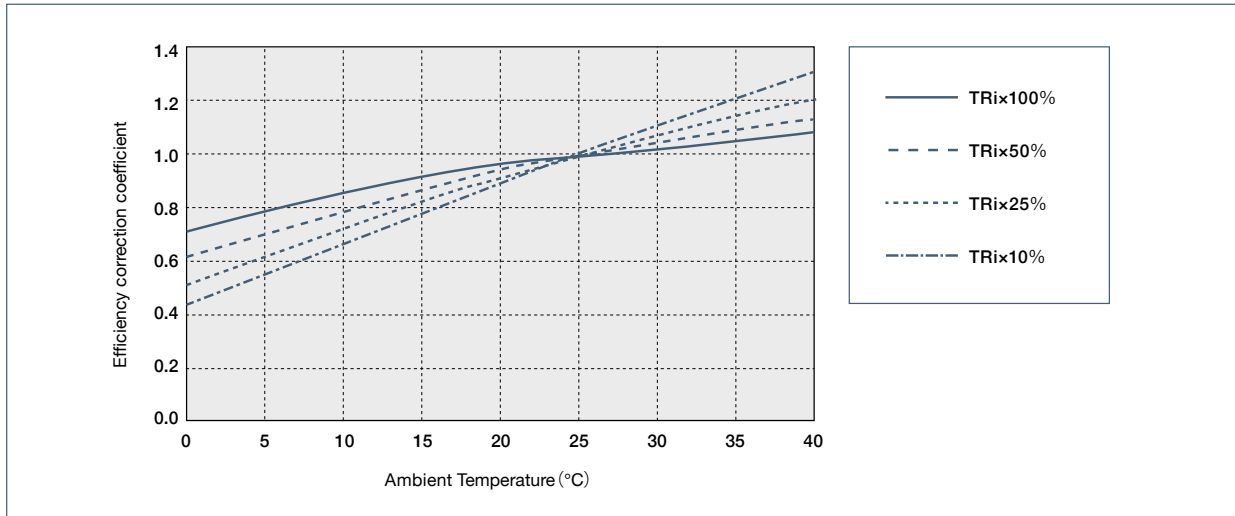

Size 11 : Gearhead

HPGP

Reduction Ratio = 5

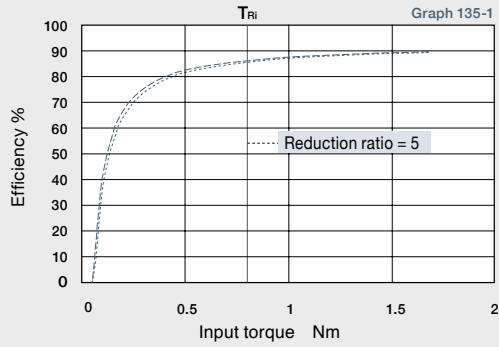

Reduction Ratio = 21

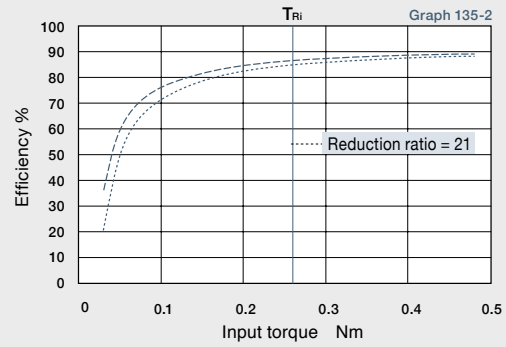

Reduction Ratio = 37, 45

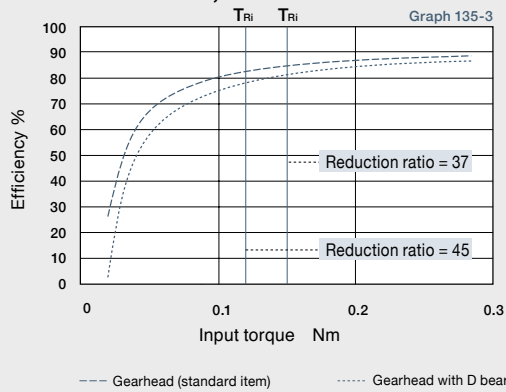

--- Gearhead (standard item) - - - - Gearhead with D bearing (double sealed) T_{Ri} Input torque corresponding to output torque

Size 14 : Gearhead

HPGP

Reduction Ratio = 5

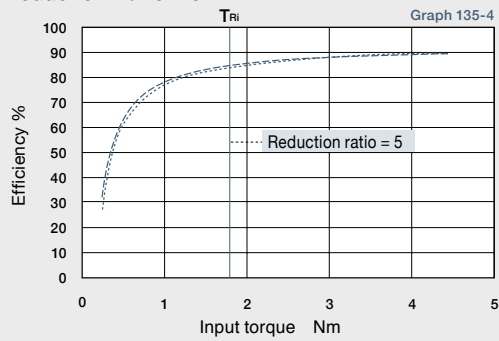

Reduction Ratio = 11

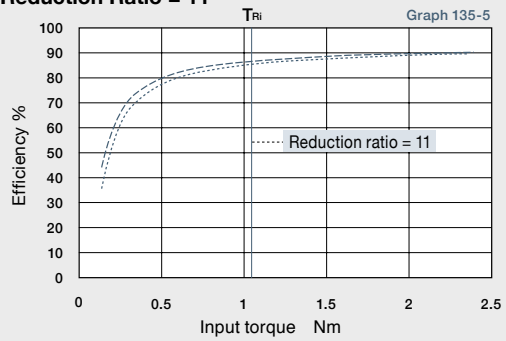

Reduction Ratio = 15, 21

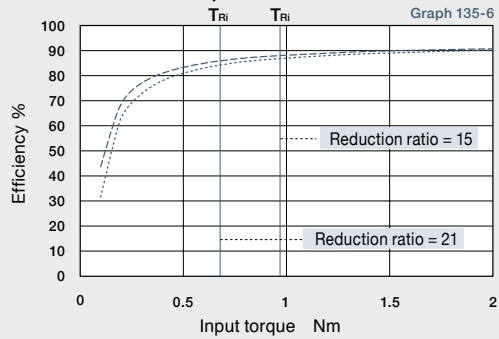

Reduction Ratio = 33, 45

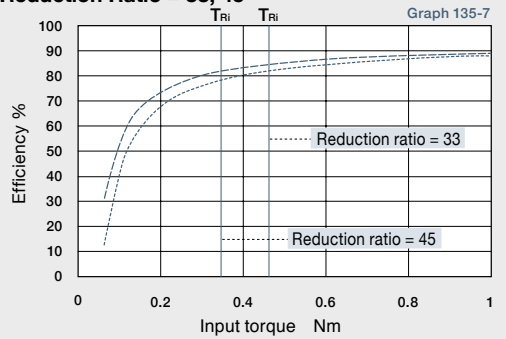

--- Gearhead (standard item) - - - - Gearhead with D bearing (double sealed) T_{Ri} Input torque corresponding to output torque

Size 20 : Gearhead

HPGP

Reduction ratio = 5

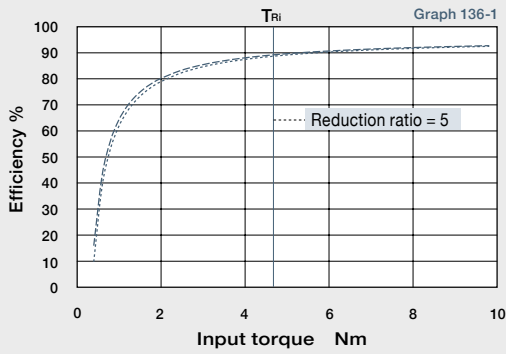

Reduction ratio = 11

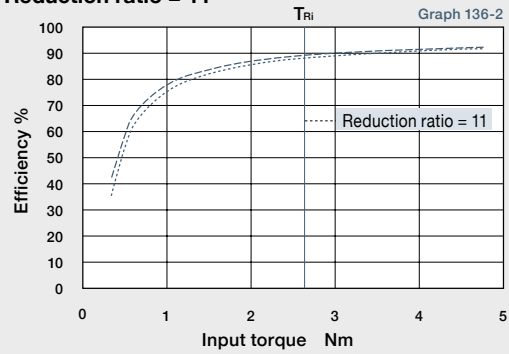

Reduction ratio = 15, 21

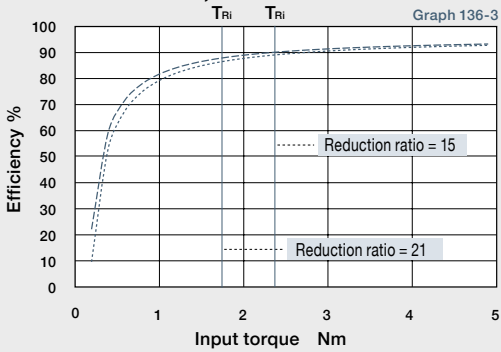

Reduction ratio = 33, 45

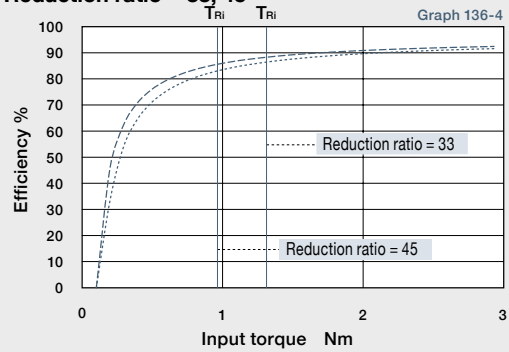

--- Gearhead (standard item)

----- Gearhead with D bearing (double sealed)

T_{Ri} Input torque corresponding to output torque

Size 32 : Gearhead

HPGP

Reduction ratio = 5 *1

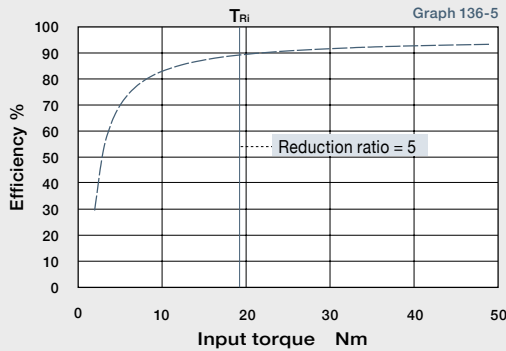

Reduction ratio = 11

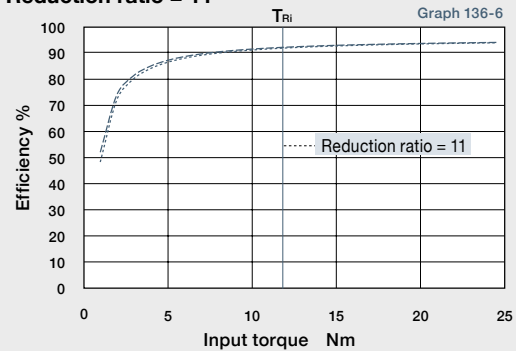

Reduction ratio = 15, 21

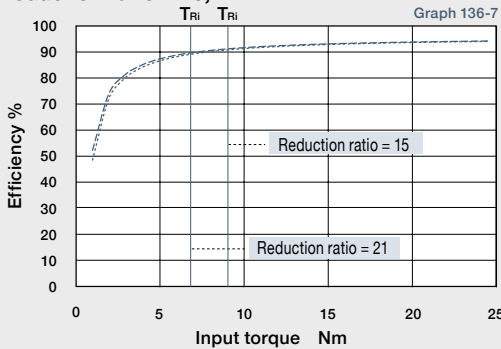

Reduction ratio = 33, 45

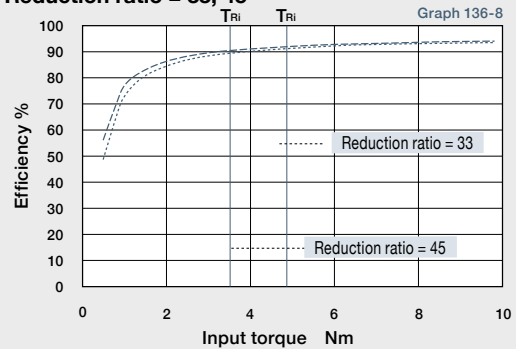

--- Gearhead (standard item)

----- Gearhead with D bearing (double sealed)

T_{Ri} Input torque corresponding to output torque

*1 Only one line is shown because the difference between the gearhead and a bearing assembled on the input side is small.

Size 50 : Gearhead

HPGP

Reduction ratio = 5 *2

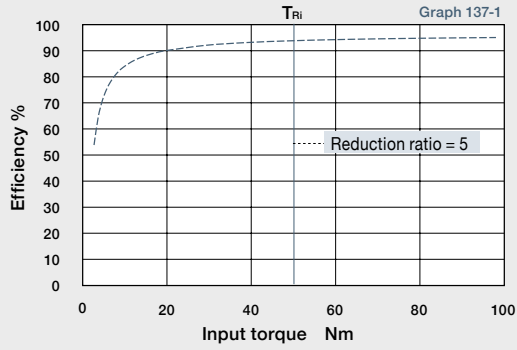

Reduction ratio = 11 *2

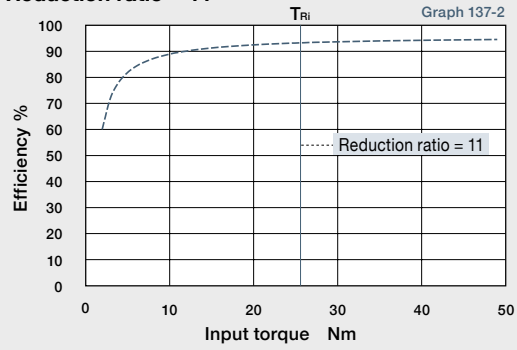

Reduction ratio = 15, 21 *2

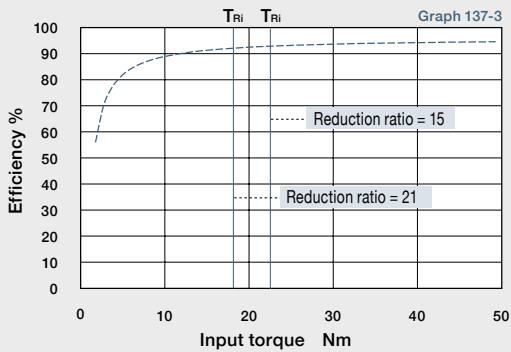

Reduction ratio = 33, 45

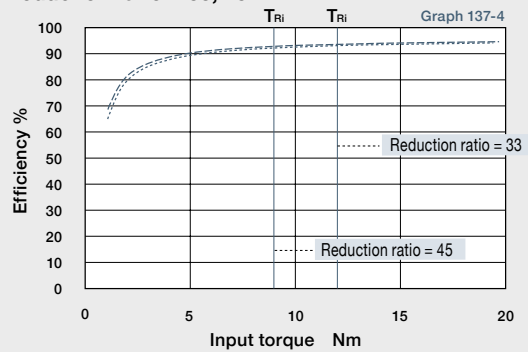

--- Gearhead (standard item)

..... Gearhead with D bearing (double sealed)

T_{Ri} Input torque corresponding to output torque

*2 Only one line is shown because the difference between the gearhead and a bearing assembled on the input side is small.

Size 65 : Gearhead

HPGP

Reduction ratio = 4, 5 *3

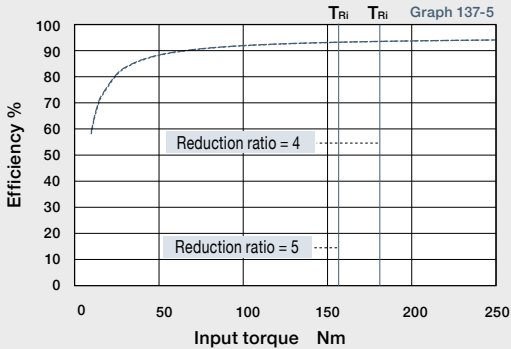

Reduction ratio = 12 *3

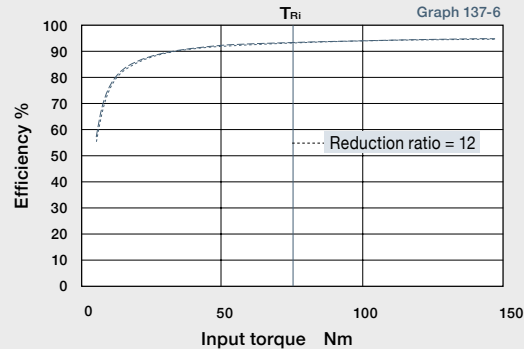

Reduction ratio = 15, 20 *3

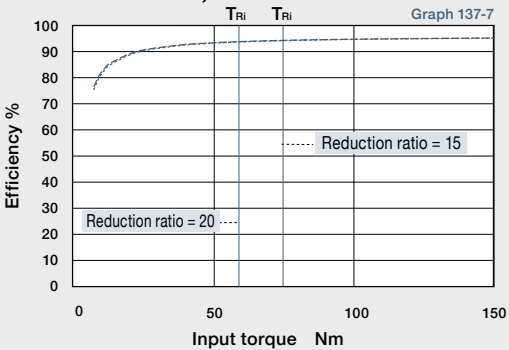

Reduction ratio = 25 *3

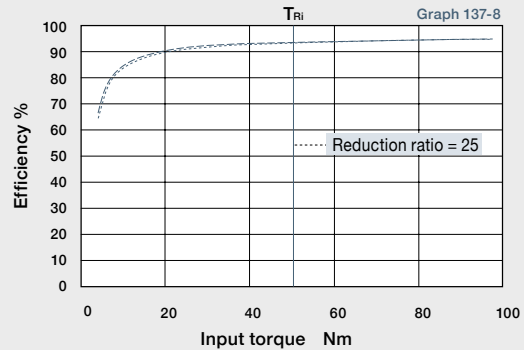

--- Gearhead (standard item)

..... Gearhead with D bearing (double sealed)

T_{Ri} Input torque corresponding to output torque

*3 Only one line is shown because the difference between the gearhead and a bearing assembled on the input side is small.

Size 11 : Gearhead & Input Shaft Unit

HPG

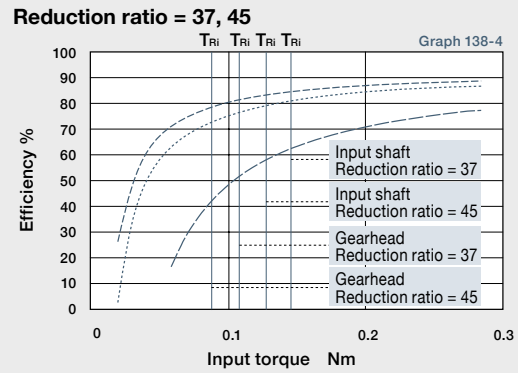
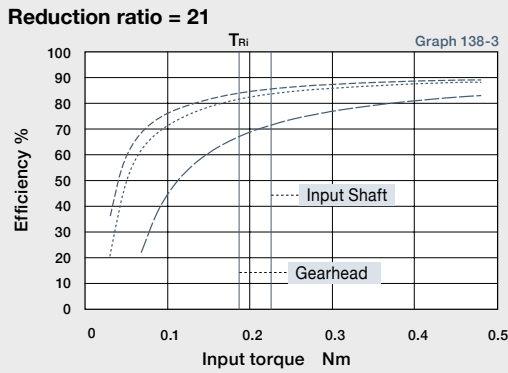
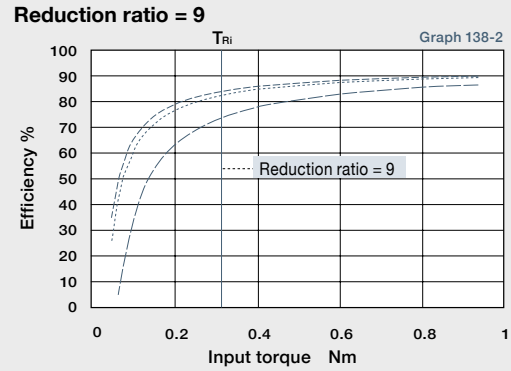
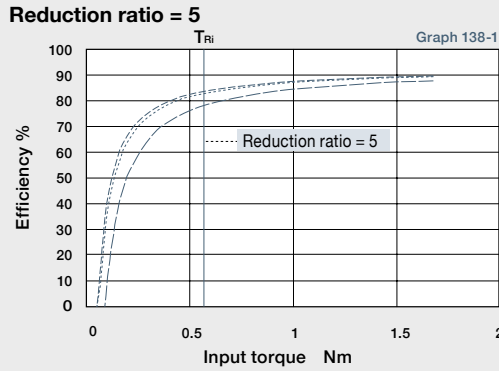

--- Gearhead (standard item)

..... Gearhead with D bearing (double sealed)

T_{Ri} Input torque corresponding to output torque

Size 14 : Gearhead & Input Shaft Unit

HPG

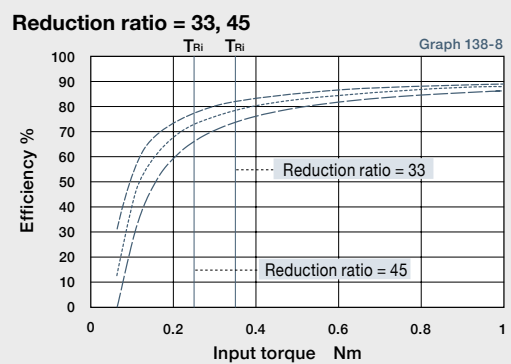
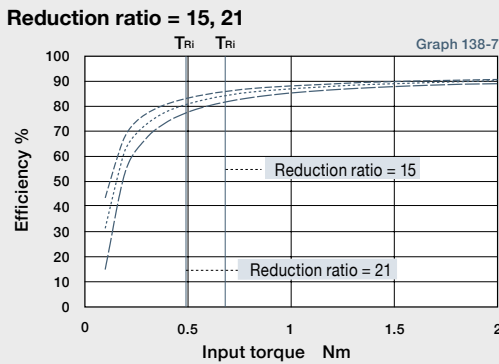
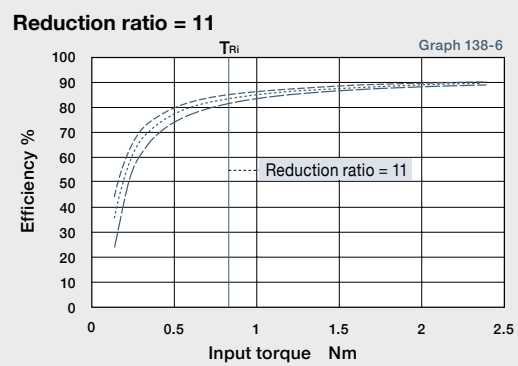
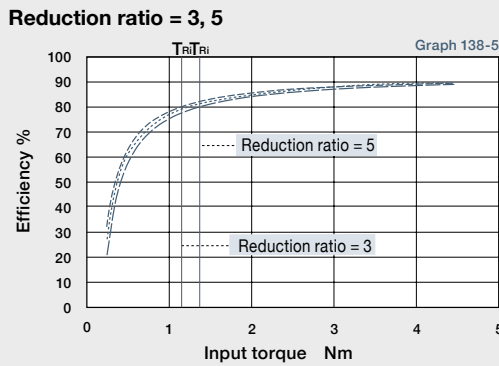

--- Gearhead (standard item)

..... Gearhead with D bearing (double sealed)

T_{Ri} Input torque corresponding to output torque

Size 20 : Gearhead & Input Shaft Unit

HPG

Reduction ratio = 3, 5

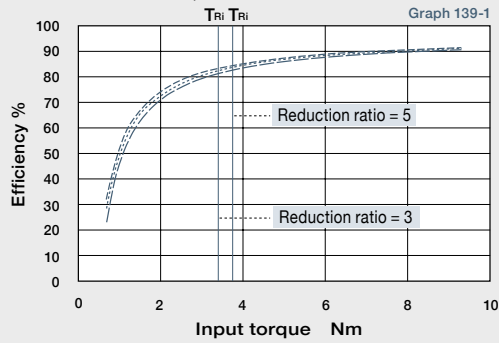

Reduction ratio = 11

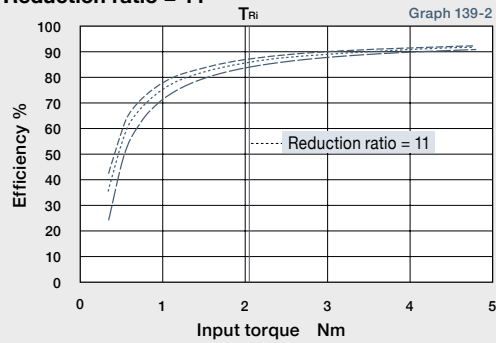

Reduction ratio = 15, 21

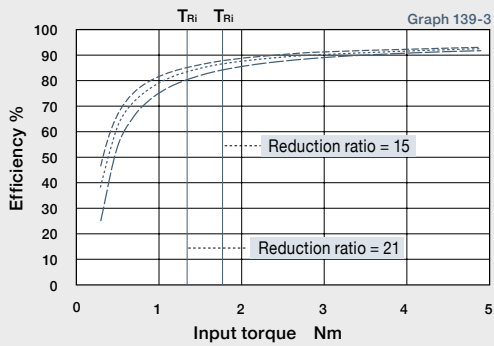

Reduction ratio = 33, 45

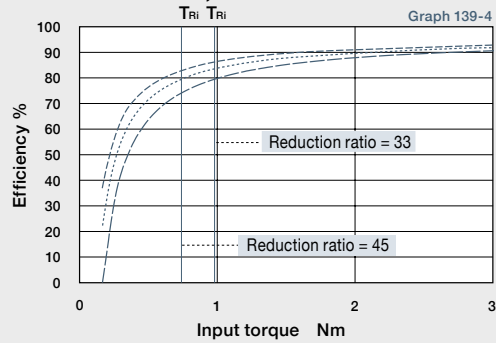

--- Gearhead (standard item) - - - - Gearhead with D bearing (double sealed) — Input Shaft T_{Ri} Input torque corresponding to output torque

Size 32 : Gearhead & Input Shaft Unit

HPG

Reduction ratio = 3, 5*1

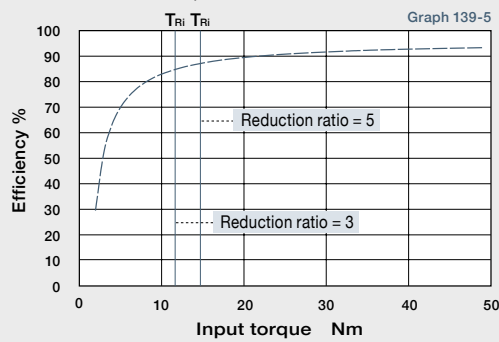

Reduction ratio = 11

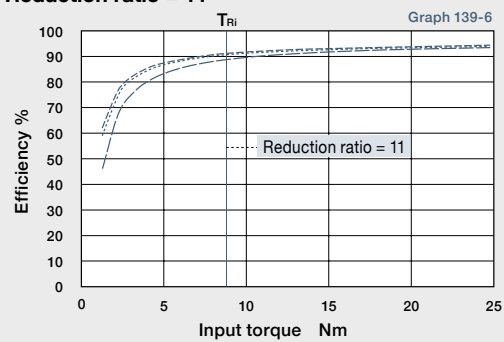

Reduction ratio = 15, 21

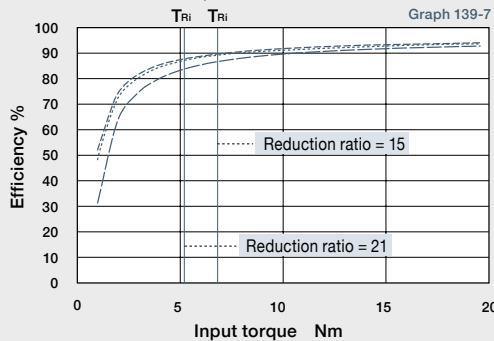

Reduction ratio = 33, 45

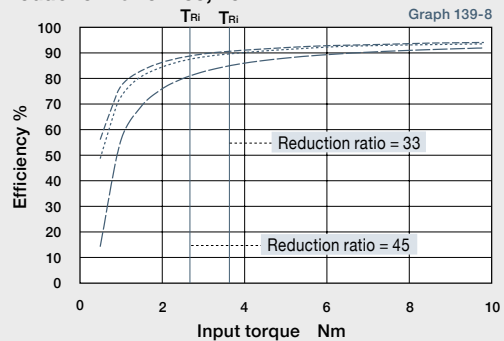

--- Gearhead (standard item) - - - - Gearhead with D bearing (double sealed) — Input Shaft T_{Ri} Input torque corresponding to output torque

*1 Only one line is shown because the difference between the gearhead and a bearing assembled on the input side is small.

Size 50 : Gearhead & Input Shaft Unit

HPG

Reduction ratio = 3, 5*2

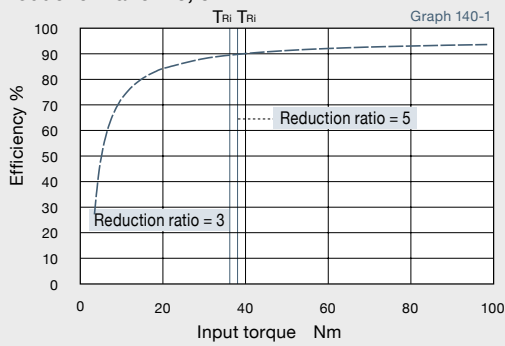

Reduction ratio = 11*2

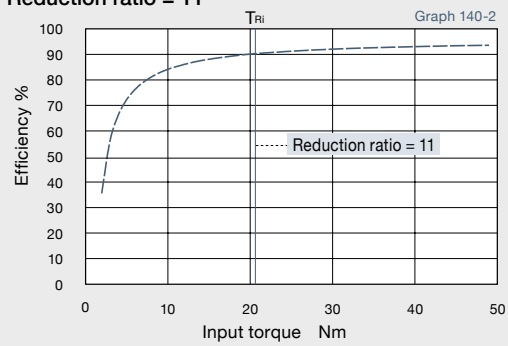

Reduction ratio = 15, 21*2

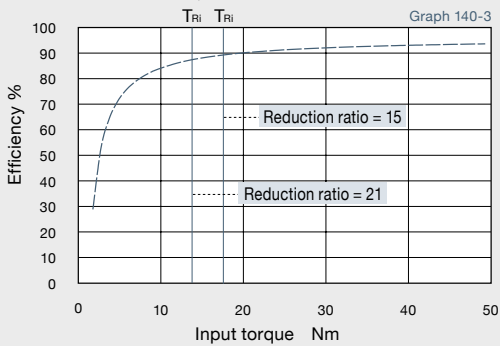

Reduction ratio = 33, 45

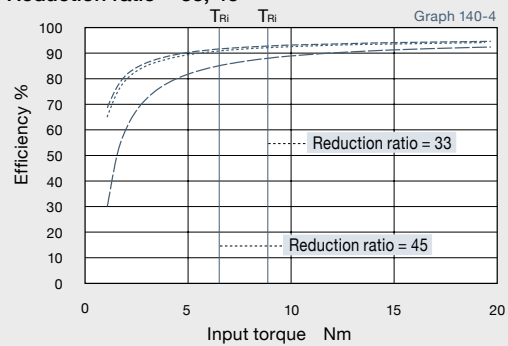

--- Gearhead (standard item) - - - - Gearhead with D bearing (double sealed) — Input Shaft T_{Ri} Input torque corresponding to output torque

*2 Only one line is shown because the difference between the gearhead and a bearing assembled on the input side is small.

Size 65 : Gearhead & Input Shaft Unit

HPG

Reduction ratio = 4, 5*3

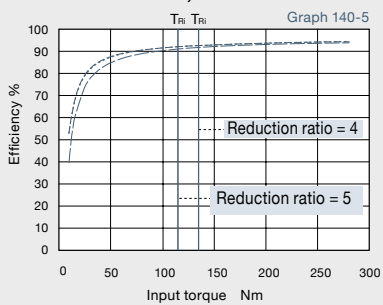

Reduction ratio = 12

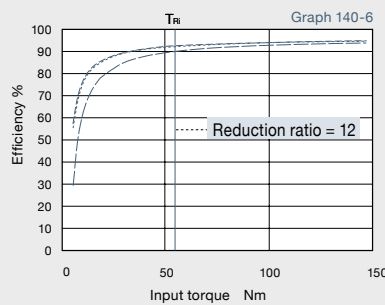

Reduction ratio = 15, 20

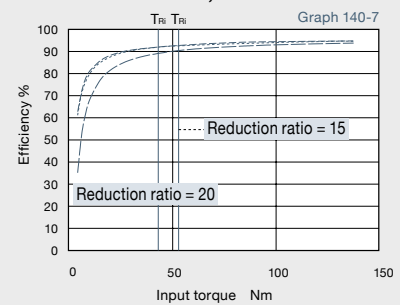

Reduction ratio = 25

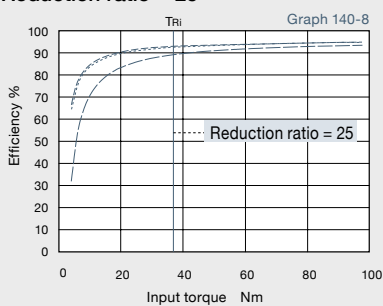

Reduction ratio = 40*3

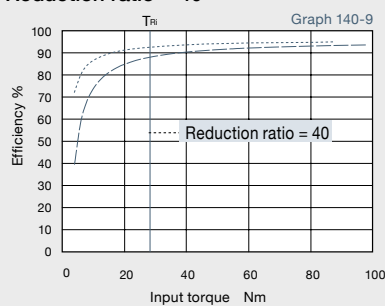

Reduction ratio = 50

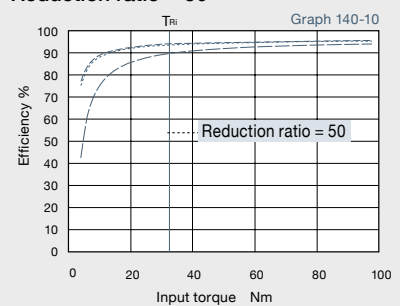

--- Gearhead (standard item) - - - - Gearhead with D bearing (double sealed) — Input Shaft T_{Ri} Input torque corresponding to output torque

*3 Only one line is shown because the difference between the gearhead and a bearing assembled on the input side is small.

Size 11

: Gearhead

HPG-Helical

Reduction ratio = 4

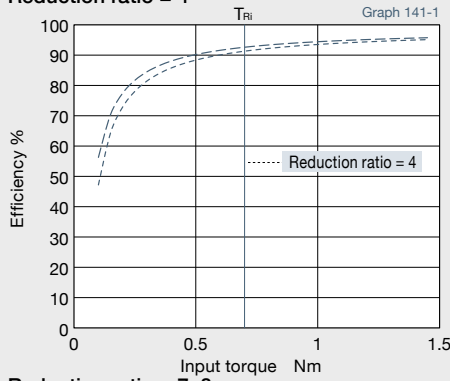

Reduction ratio = 5, 6

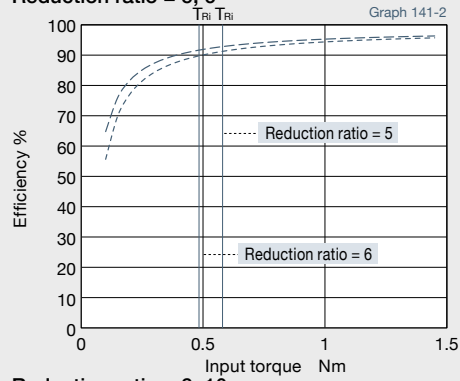

Reduction ratio = 7, 8

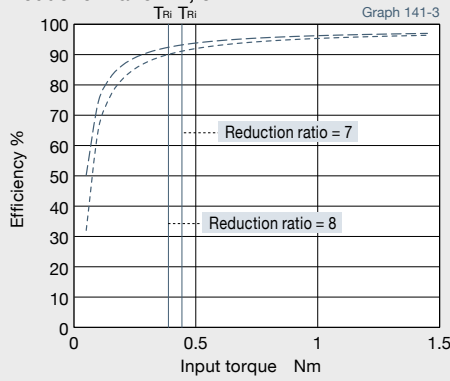

Reduction ratio = 9, 10

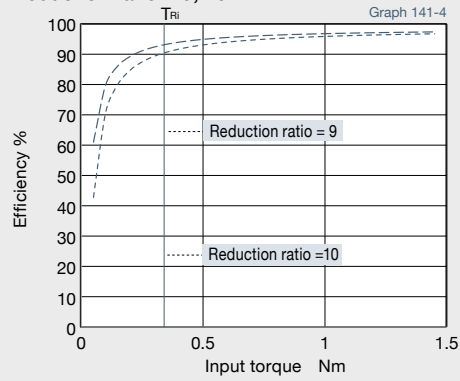

--- Gearhead with Z bearing (Double shielded)

..... Gearhead with D bearing (double sealed)

T_{Ri} Input torque corresponding to output torque

Size 14

: Gearhead

HPG-Helical

Reduction ratio = 3, 4

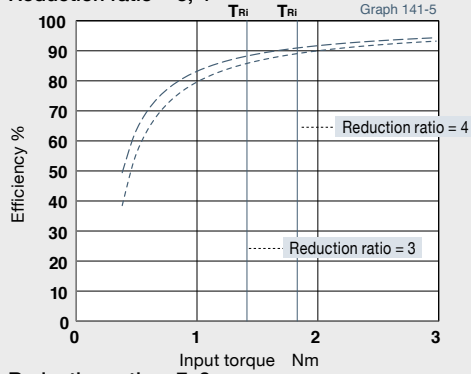

Reduction ratio = 5, 6

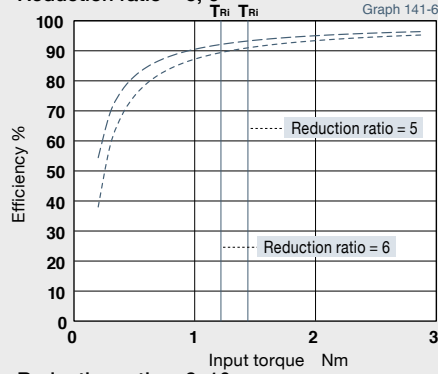

Reduction ratio = 7, 8

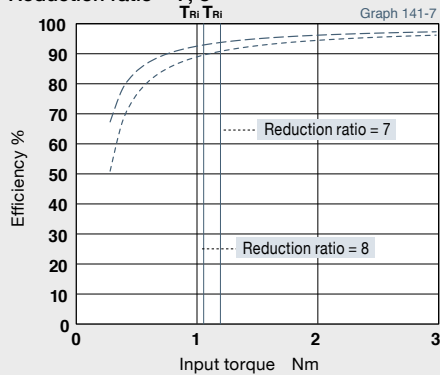

Reduction ratio = 9, 10

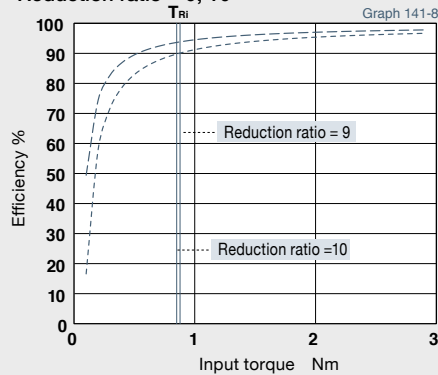

--- Gearhead with Z bearing (Double shielded)

..... Gearhead with D bearing (double sealed)

T_{Ri} Input torque corresponding to output torque

Size 20 : Gearhead

HPG-Helical

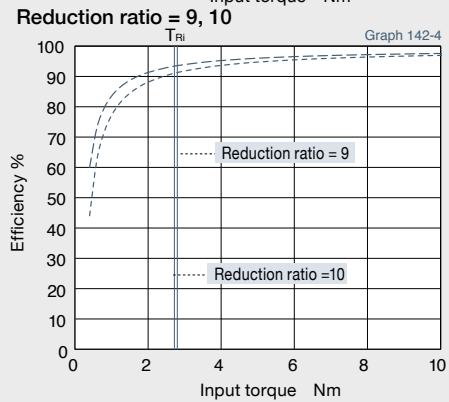
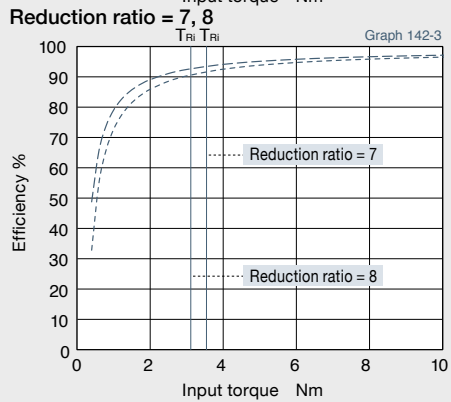
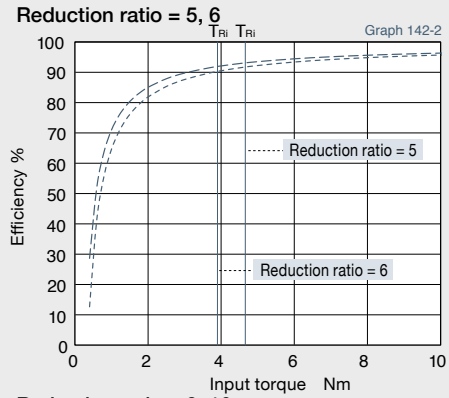
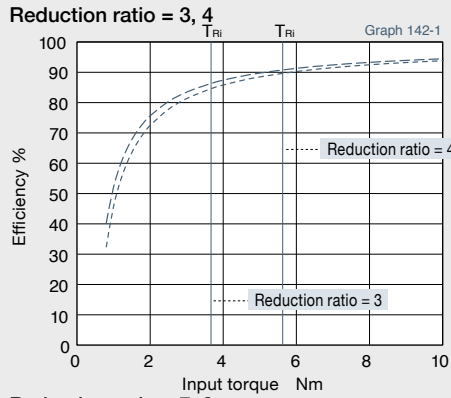

--- Gearhead with Z bearing (Double shielded) - - - - - Gearhead with D bearing (double sealed) T_{Ri} Input torque corresponding to output torque

Size 32 : Gearhead

HPG-Helical

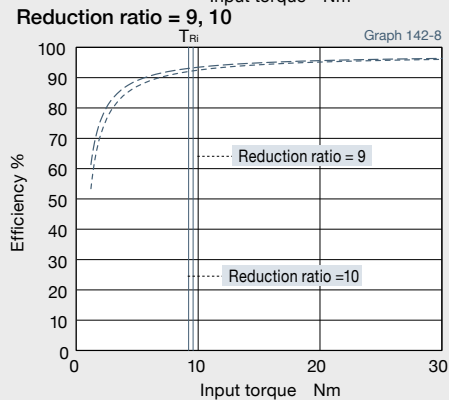
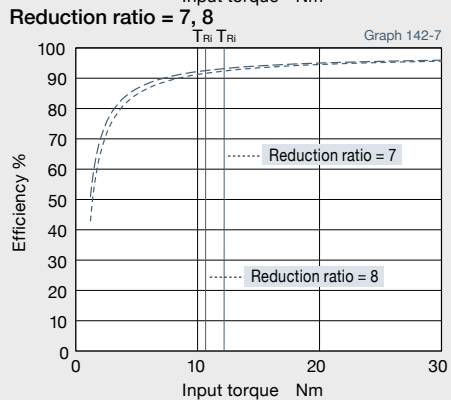
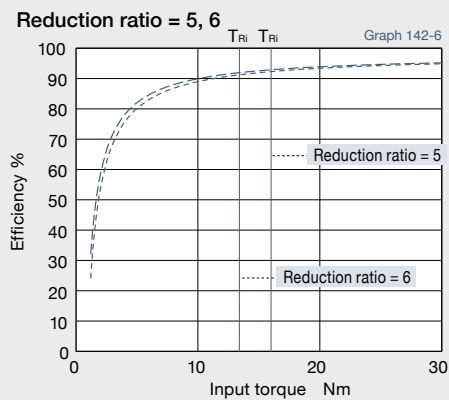
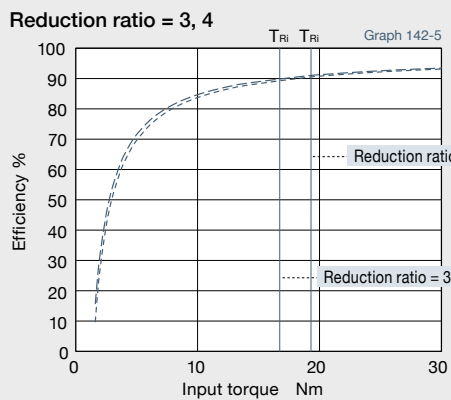

--- Gearhead with Z bearing (Double shielded) - - - - - Gearhead with D bearing (double sealed) T_{Ri} Input torque corresponding to output torque

Size 32 RA3 : Right Angle Gearhead

HPG

Reduction ratio = 5

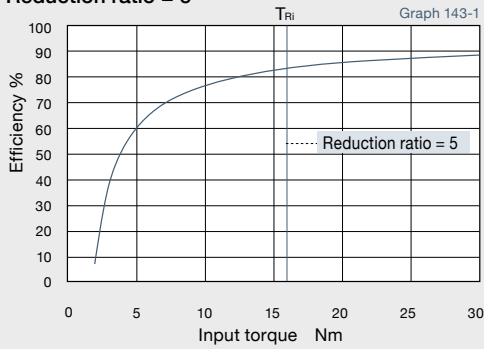

Reduction ratio = 11

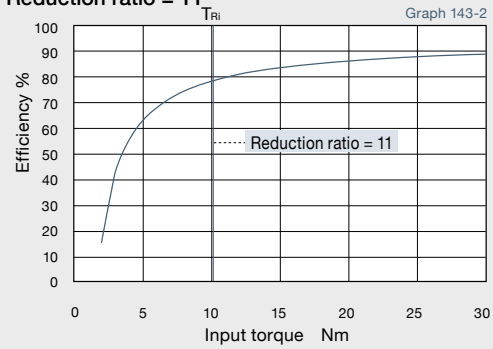

Reduction ratio = 15, 21

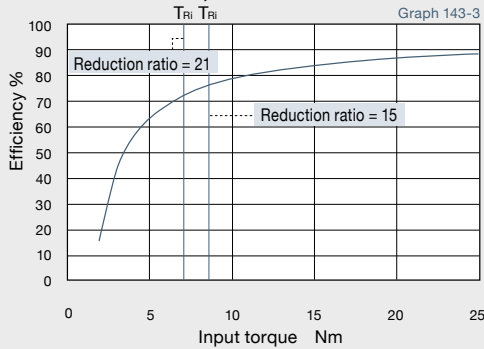

Reduction ratio = 33, 45

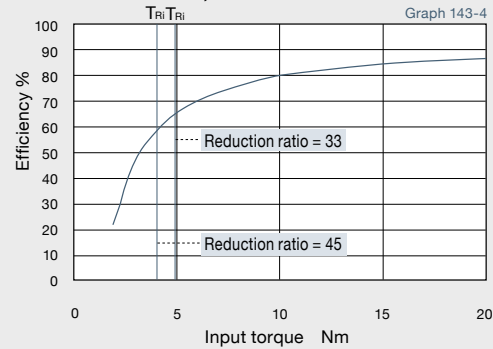

T_{Ri} Input torque corresponding to output torque

Size 50 RA3 : Right Angle Gearhead

HPG

Reduction ratio = 5

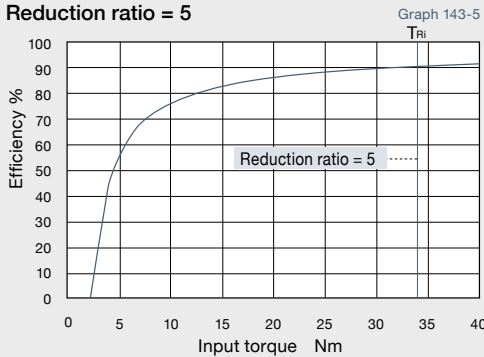

Reduction ratio = 11

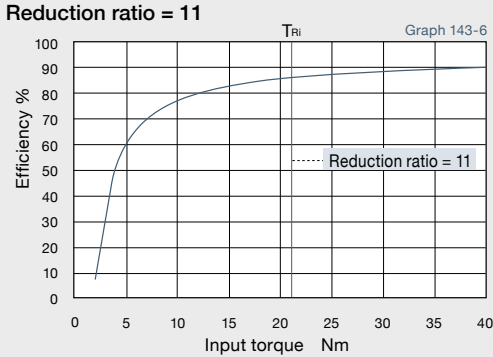

Reduction ratio = 15, 21

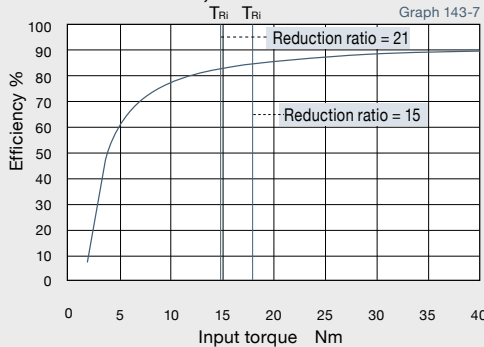

Reduction ratio = 33, 45

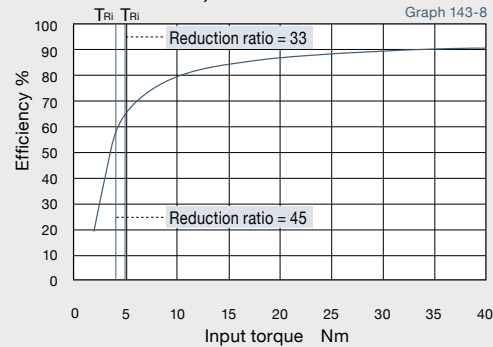

T_{Ri} Input torque corresponding to output torque

Size 50 RA5 : Right Angle Gearhead

HPG

Reduction ratio = 5

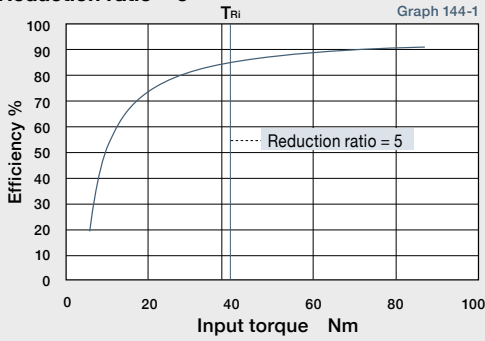

Reduction ratio = 11

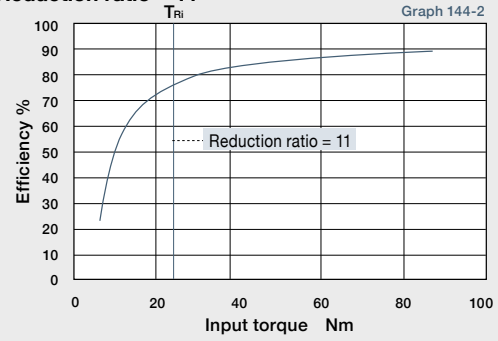

Reduction ratio = 15, 21

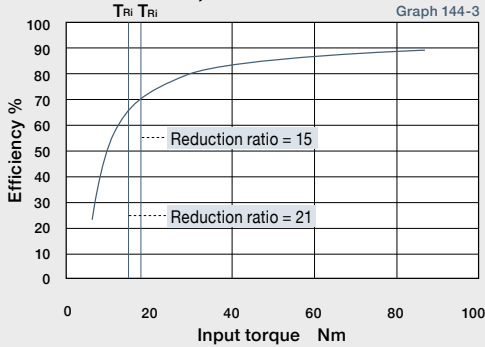

Reduction ratio = 33, 45

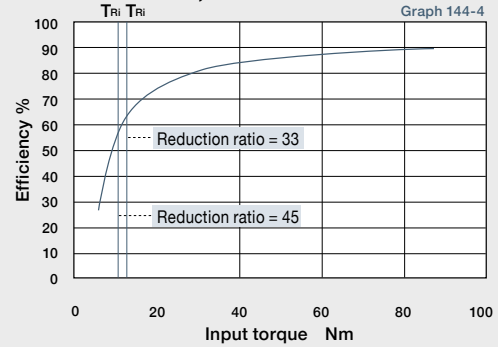

T_{Ri} Input torque corresponding to output torque

Size 65 RA5 : Right Angle Gearhead

HPG

Reduction ratio = 5

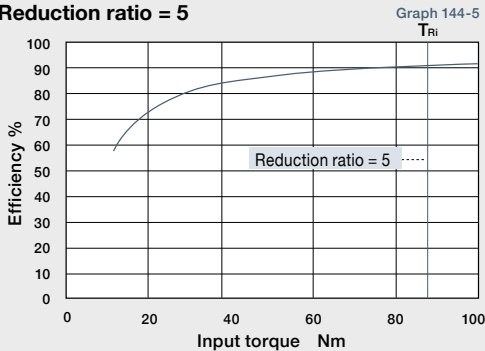

Reduction ratio = 12, 15

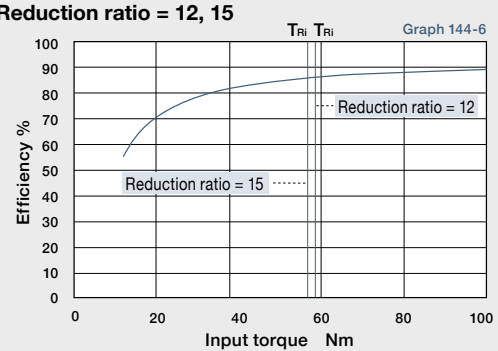

Reduction ratio = 20, 25

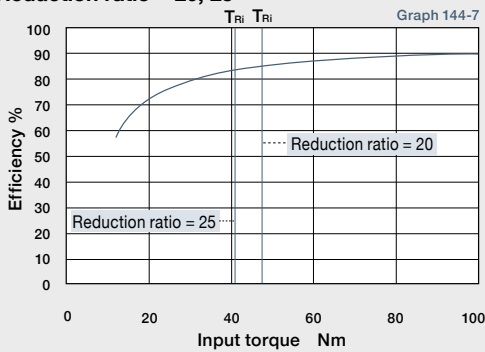

Reduction ratio = 40, 50

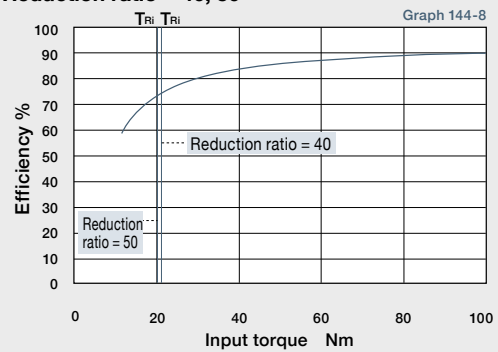

T_{Ri} Input torque corresponding to output torque

Size 11

HPN

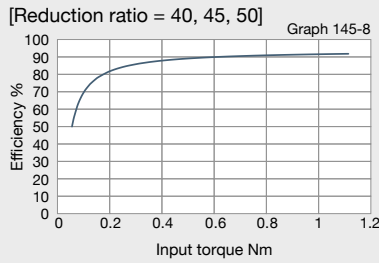
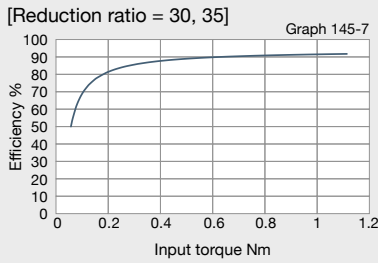
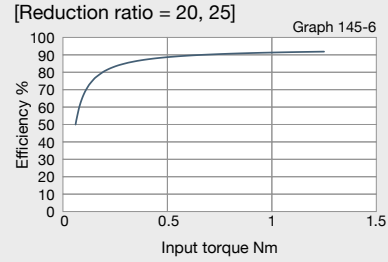
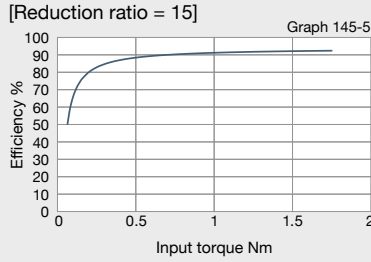
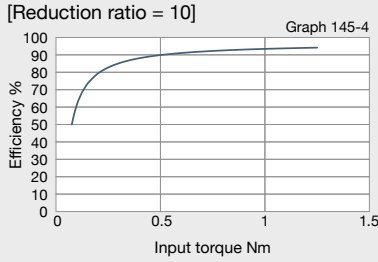
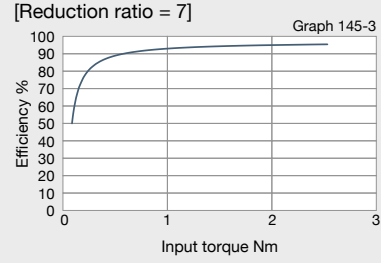
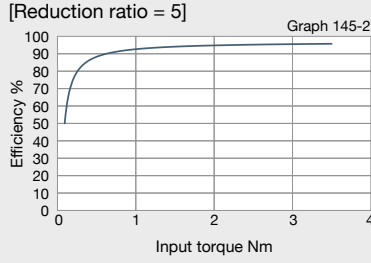
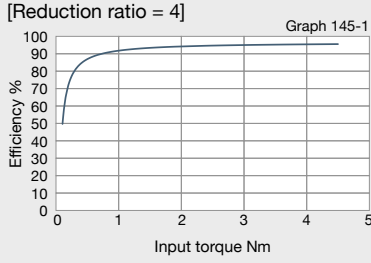

Size 14

HPN

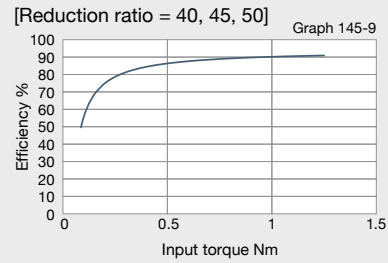
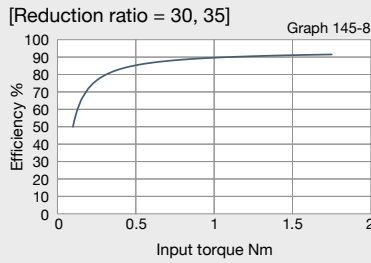
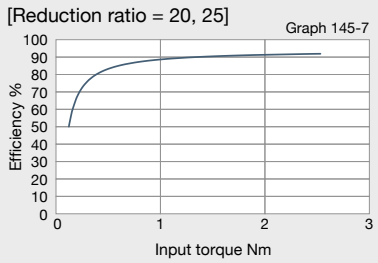
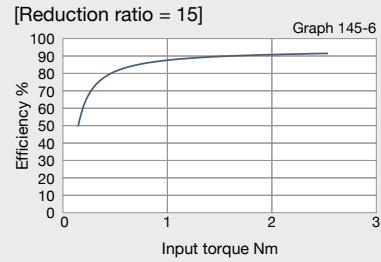
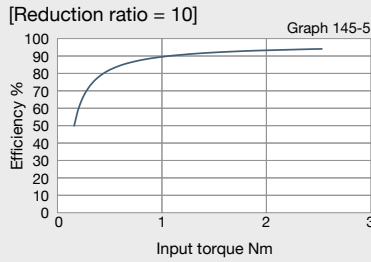
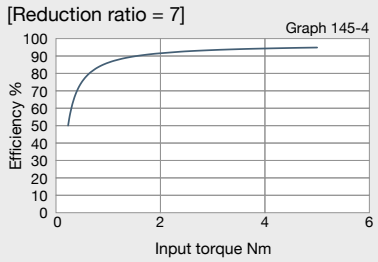
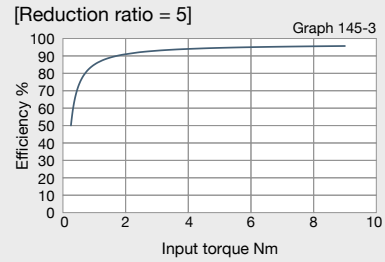
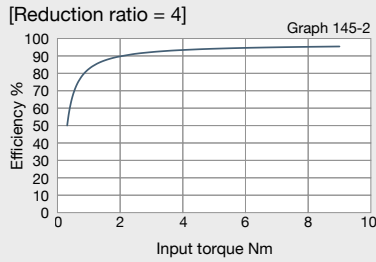
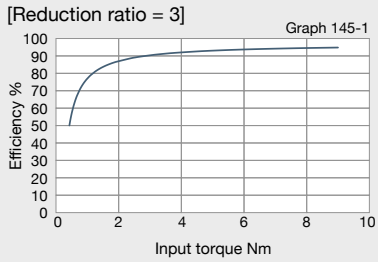

Size 20

HPN

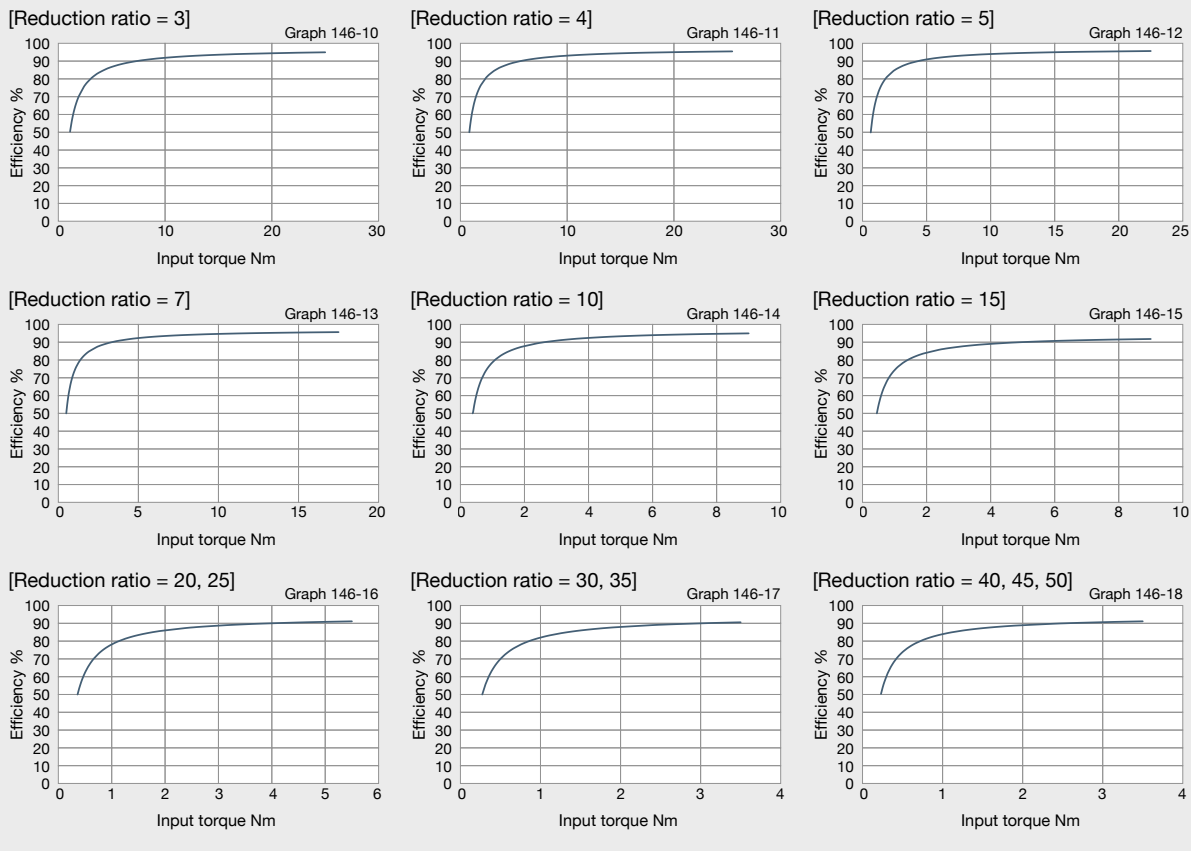

Size 32

HPN

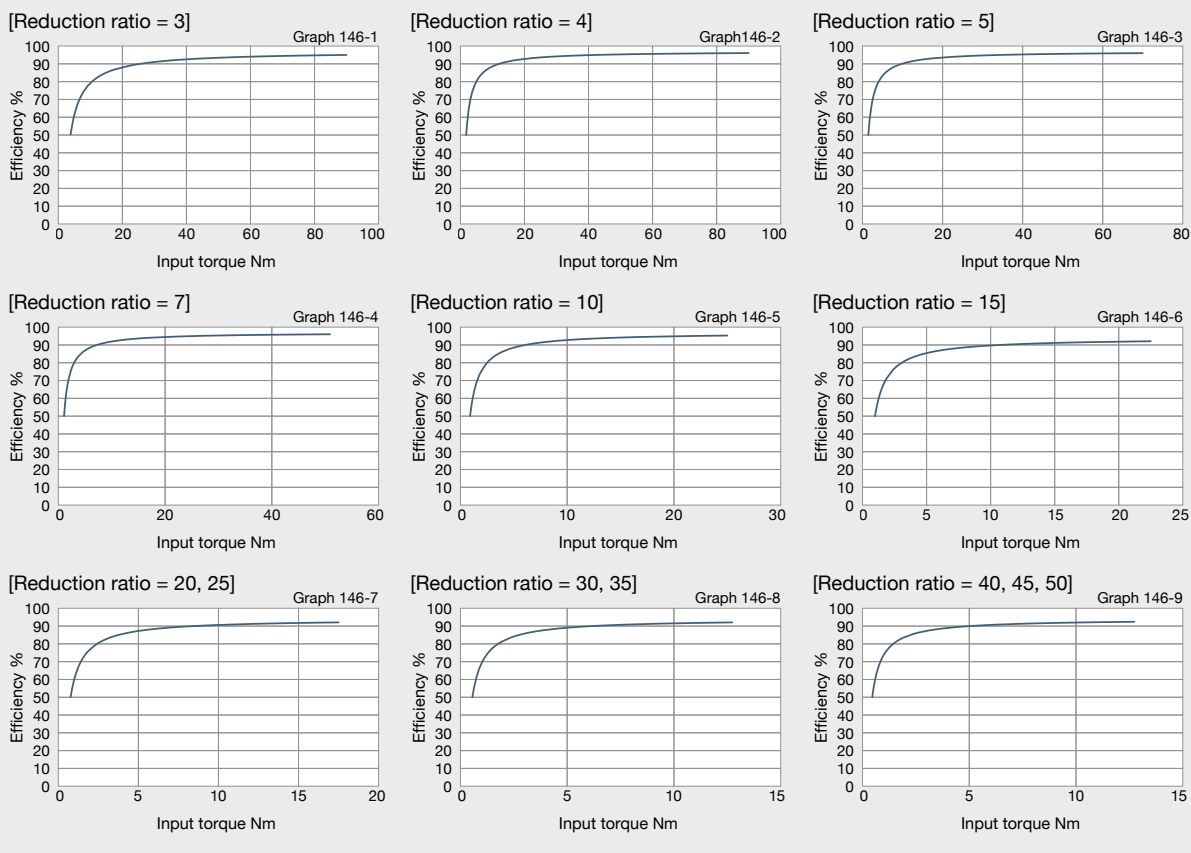

Size 40

HPN

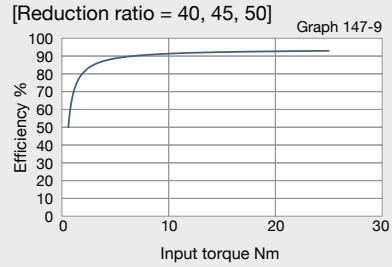
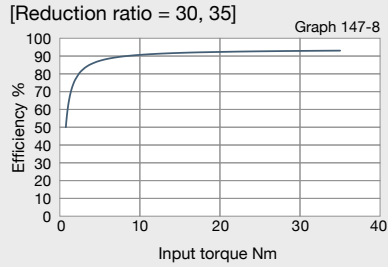
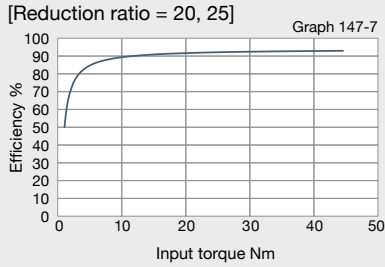
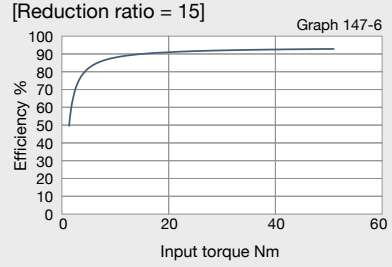
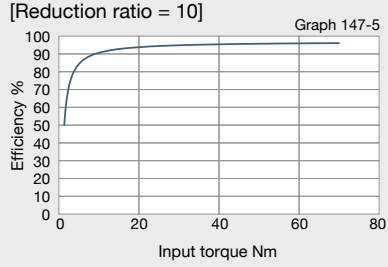
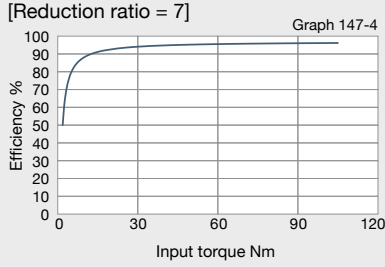
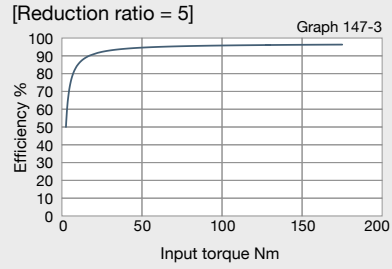
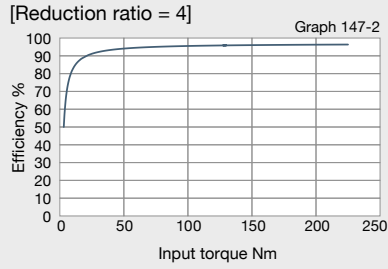
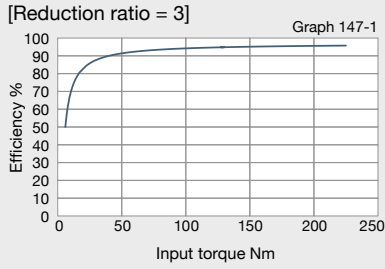

Size 25 : Hollow Shaft Unit

HPF

Reduction ratio = 11

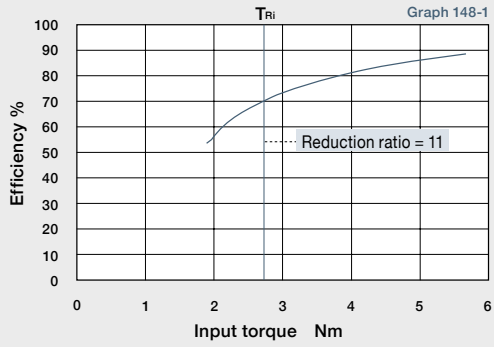

Size 32 : Hollow Shaft Unit

HPF

Reduction ratio = 11

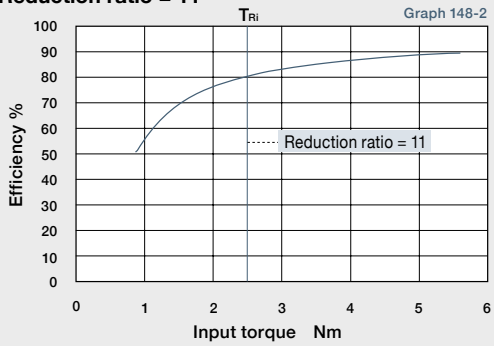

Size 14

: Gearhead

CSG-GH

CSF-GH

Reduction ratio = 50

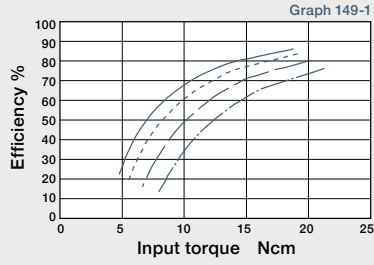

Reduction ratio = 80

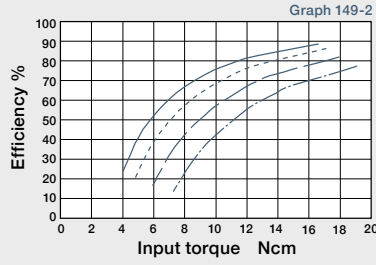

Reduction ratio = 100

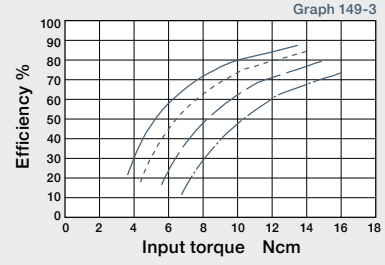

Input rotational speed — 500 rpm - - - - - 1000 rpm - · - · - 2000 rpm - - - - - 3500 rpm

Size 20

: Gearhead

CSG-GH

CSF-GH

Reduction ratio = 50

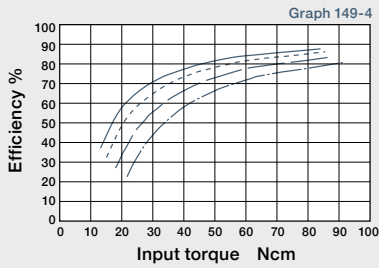

Reduction ratio = 80

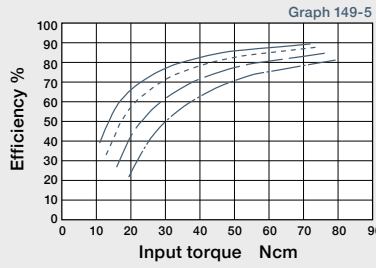

Reduction ratio = 100

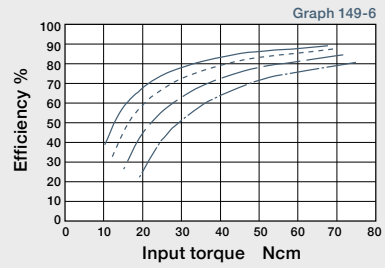

Reduction ratio = 120

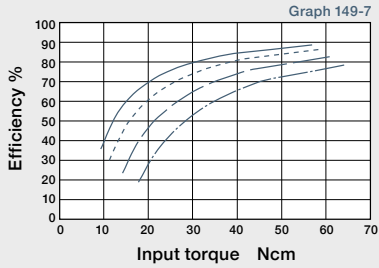

Reduction ratio = 160

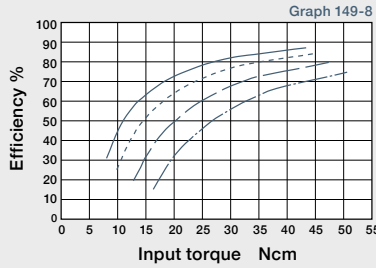

Input rotational speed — 500 rpm - - - - - 1000 rpm - · - · - 2000 rpm - - - - - 3500 rpm

Size 32 : Gearhead

CSG-GH

CSF-GH

Reduction ratio = 50

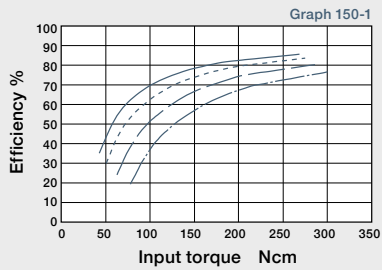

Reduction ratio = 80

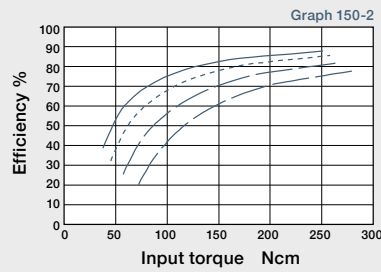

Reduction ratio = 100

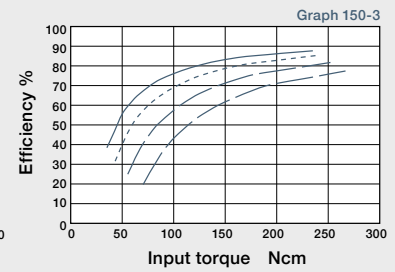

Reduction ratio = 120

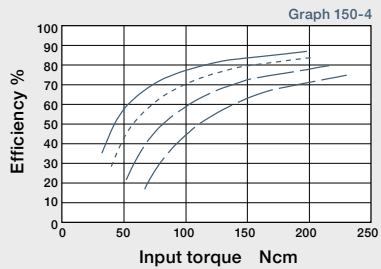

Reduction ratio = 160

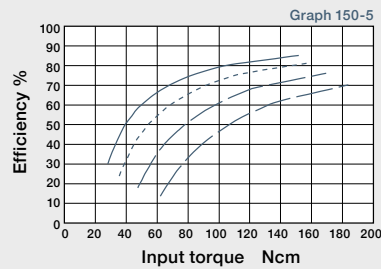

Input rotational speed ——— 500 rpm - - - - - 1000 rpm ——— 2000 rpm ——— 3500 rpm

Size 45 : Gearhead

CSG-GH

CSF-GH

Reduction ratio = 50

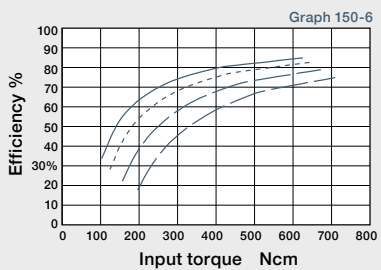

Reduction ratio = 80

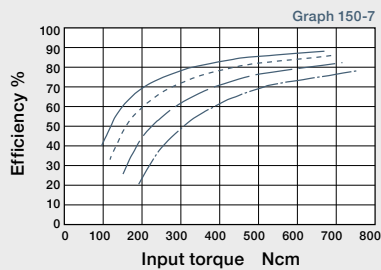

Reduction ratio = 100

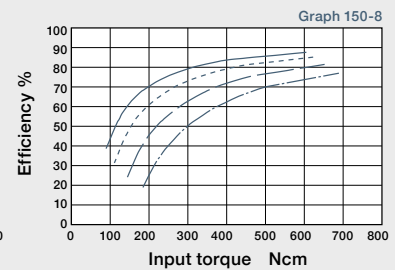

Reduction ratio = 120

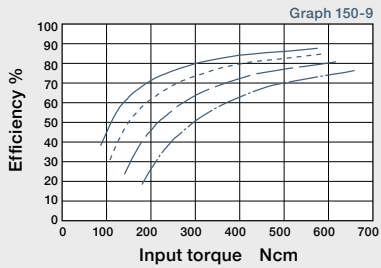

Reduction ratio = 160

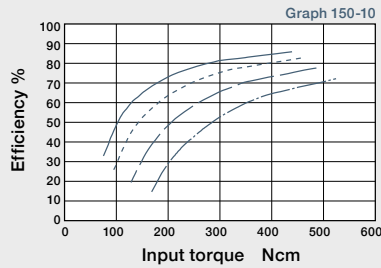

Input rotational speed ——— 500 rpm - - - - - 1000 rpm ——— 2000 rpm ——— 3500 rpm

Size 65

: Gearhead

CSG-GH

CSF-GH

Reduction ratio = 80

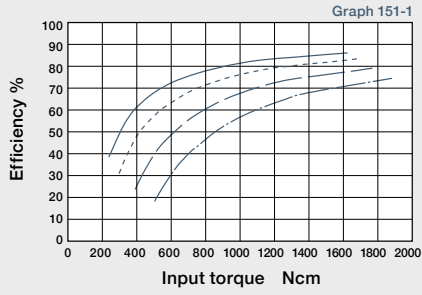

Reduction ratio = 100

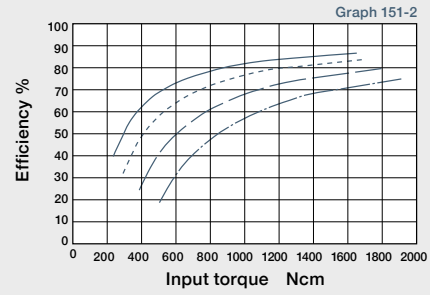

Reduction ratio = 120

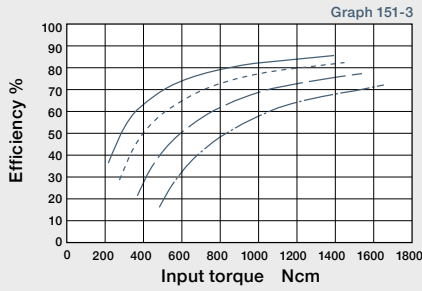

Reduction ratio = 160

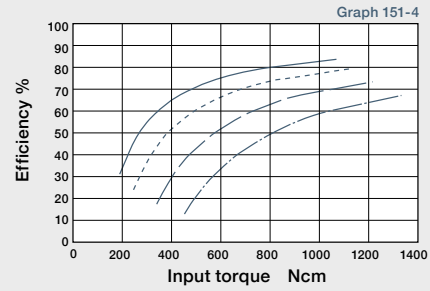

Input rotational speed — 500 rpm - - - - - 1000 rpm ——— 2000 rpm ——— 3500 rpm

Output Shaft Bearing Load Limits

HPN Series Output Shaft Load Limits are plotted below.

HPN uses deep groove ball bearings to support the output shaft. Please use the curve on the graph for the appropriate load coefficient (f_w) that represents the expected operating condition.

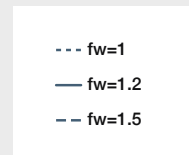
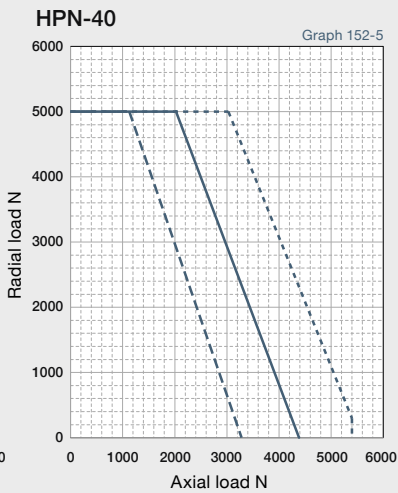
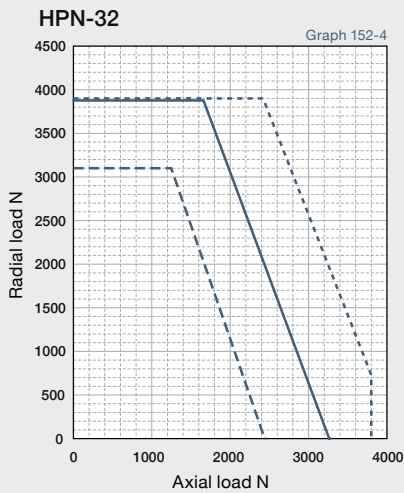
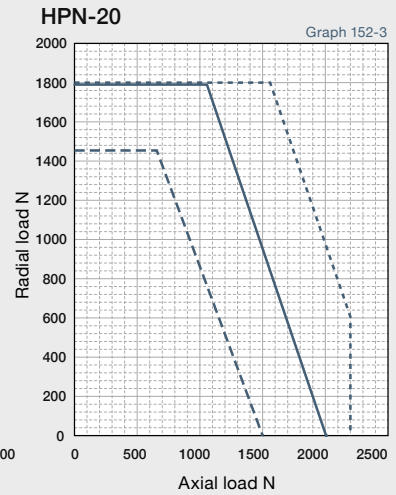
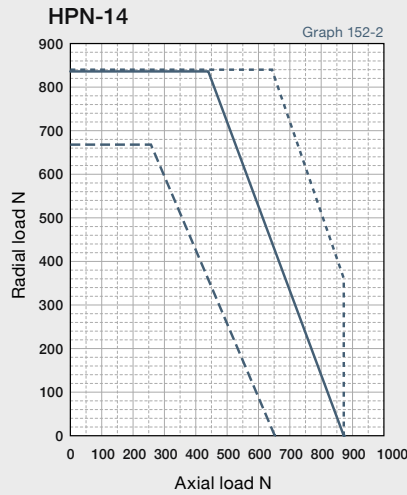
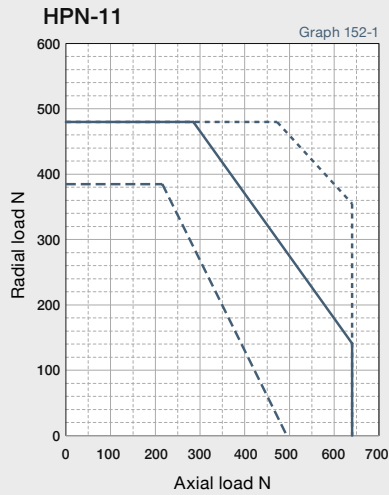

Load coefficient
 $f_w=1-1.2$ Smooth operation
 without impact
 $f_w=1.2-1.5$ Standard operation

Output shaft speed - 100 rpm, bearing life is based on 20,000 hours. The load-point is based on shaft center of radial load and axial load.

Output Bearing Specifications and Checking Procedure

HPGP, HPG, HPG Helical, CSF-GH, CSG-GH, HPF, and HPG-U1 are equipped with cross roller bearings. A precision cross roller bearing supports the external load (output flange). Check the maximum load, moment load, life of the bearing and static safety coefficient to maximize performance.

Checking procedure

(1) Checking the maximum moment load (M max)

Calculate the maximum moment load (M max). ●●▶ Maximum moment load (M max) ≤ Permissible moment (Mc)

(2) Checking the life

Calculate the average radial load (F_{rav}) and the average axial load (F_{axv}). ●●▶ Calculate the radial load coefficient (X) and the axial load coefficient (Y). ●●▶ Calculate the life and check it.

(3) Checking the static safety coefficient

Calculate the static equivalent radial load coefficient (P_o). ●●▶ Check the static safety coefficient. (f_s)

Specification of output bearing

HPGP/HPG Series Tables 153-1, -2 and -3 indicate the cross roller bearing specifications for in-line, right angle and input shaft gears.

Table 153-1

| Size | Pitch circle | Offset amount | Basic rated load | | | | Allowable moment load Mc ^{*3} | | Moment stiffness Km ^{*4} | |
|------|--------------|---------------|---|------|---|-------|--|-------|-----------------------------------|-------------------|
| | dp | R | Basic dynamic load rating C ^{*1} | | Basic static load rating Co ^{*2} | | Nm | Kgf·m | x10 ⁴ Nm/rad | Kgf·m/ arc min |
| | m | m | N | kgf | N | kgf | | | | |
| 11 | 0.0275 | 0.006 | 3116 | 318 | 4087 | 417 | 9.50 | 0.97 | 0.88 | 0.26 |
| 14 | 0.0405 | 0.011 | 5110 | 521 | 7060 | 720 | 32.3 | 3.30 | 3.0 | 0.90 |
| 20 | 0.064 | 0.0115 | 10600 | 1082 | 17300 | 1765 | 183 | 18.7 | 16.8 | 5.0 |
| 32 | 0.085 | 0.014 | 20500 | 2092 | 32800 | 3347 | 452 | 46.1 | 42.1 | 12.5 |
| 50 | 0.123 | 0.019 | 41600 | 4245 | 76000 | 7755 | 1076 | 110 | 100 | 29.7 |
| 65 | 0.170 | 0.023 | 90600 | 9245 | 148000 | 15102 | 3900 | 398 | 364 | 108 |

Table 153-2

| Size | Reduction ratio | Allowable radial load ^{*5} | Allowable axial load ^{*5} |
|------|-----------------|-------------------------------------|------------------------------------|
| | | N | N |
| 11 | 5 | 280 | 430 |
| | (9) | 340 | 510 |
| | 21 | 440 | 660 |
| | 37 | 520 | 780 |
| | 45 | 550 | 830 |
| 14 | (3) | 400 | 600 |
| | 5 | 470 | 700 |
| | 11 | 600 | 890 |
| | 15 | 650 | 980 |
| | 21 | 720 | 1080 |
| | 33 | 830 | 1240 |
| 20 | 45 | 910 | 1360 |
| | (3) | 840 | 1250 |
| | 5 | 980 | 1460 |
| | 11 | 1240 | 1850 |
| | 15 | 1360 | 2030 |
| | 21 | 1510 | 2250 |
| | 33 | 1729 | 2580 |
| 45 | 1890 | 2830 | |

* The ratio specified in parentheses is for the HPG Series.

Table 153-3

| Size | Reduction ratio | Allowable radial load ^{*5} | Allowable axial load ^{*5} |
|------|-----------------|-------------------------------------|------------------------------------|
| | | N | N |
| 32 | (3) | 1630 | 2430 |
| | 5 | 1900 | 2830 |
| | 11 | 2410 | 3590 |
| | 15 | 2640 | 3940 |
| | 21 | 2920 | 4360 |
| | 33 | 3340 | 4990 |
| | 45 | 3670 | 5480 |
| 50 | (3) | 3700 | 5570 |
| | 5 | 4350 | 6490 |
| | 11 | 5500 | 8220 |
| | 15 | 6050 | 9030 |
| | 21 | 6690 | 9980 |
| | 33 | 7660 | 11400 |
| | 45 | 8400 | 12500 |
| 65 | 4 | 8860 | 13200 |
| | 5 | 9470 | 14100 |
| | 12 | 12300 | 18300 |
| | 15 | 13100 | 19600 |
| | 20 | 14300 | 21400 |
| | 25 | 15300 | 22900 |
| | (40) | 17600 | 26300 |
| | (50) | 18900 | 28200 |

* The ratio specified in parentheses is for the HPG Series.

[Note: Table 153-1, -2 and -3 Table 154-1 and -2]

- *1 The basic dynamic load rating means a certain static radial load so that the basic dynamic rated life of the roller bearing is a million rotations.
- *2 The basic static load rating means a static load that gives a certain level of contact stress (4kN/mm²) in the center of the contact area between rolling element receiving the maximum load and orbit.
- *3 The allowable moment load is a maximum moment load applied to the bearing. Within the allowable range, basic performance is maintained and the bearing is operable. Check the bearing life based on the calculations shown on the next page.
- *4 The value of the moment stiffness is the average value.
- *5 The allowable radial load and allowable axial load are the values that satisfy the life of a speed reducer when a pure radial load or an axial load applies to the main bearing. (Lr + R = 0 mm for radial load and La = 0 mm for axial load) If a compound load applies, refer to the calculations shown on the next page.



CSG-GH/CSF-GH Series Table 154-1 indicates the specifications for cross roller bearing.

Table 154-1

| Size | Pitch circle | Offset amount | Basic load rating | | | | Allowable moment load Mc* ³ | | Moment stiffness Km* ⁴ | | Allowable radial load* ⁵ | Allowable axial load* ⁵ |
|------|--------------|---------------|---|------|---|-------|--|------|-----------------------------------|------------------|-------------------------------------|------------------------------------|
| | dp | R | Basic dynamic load rating C* ¹ | | Basic static load rating Co* ² | | Nm | kgfm | ×10 ⁴ Nm/rad | kgfm/ arc min | | |
| | m | m | N | kgf | N | kgf | | | | | N | N |
| 14 | 0.0405 | 0.011 | 5110 | 521 | 7060 | 720 | 27 | 2.76 | 3.0 | 0.89 | 732 | 1093 |
| 20 | 0.064 | 0.0115 | 10600 | 1082 | 17300 | 1765 | 145 | 14.8 | 17 | 5.0 | 1519 | 2267 |
| 32 | 0.085 | 0.014 | 20500 | 2092 | 32800 | 3347 | 258 | 26.3 | 42 | 12 | 2938 | 4385 |
| 45 | 0.123 | 0.019 | 41600 | 4245 | 76000 | 7755 | 797 | 81.3 | 100 | 30 | 5962 | 8899 |
| 65 | 0.170 | 0.0225 | 81600 | 8327 | 149000 | 15204 | 2156 | 220 | 323 | 96 | 11693 | 17454 |

HPF Series Table 154-2 indicates the specifications for cross roller bearing.

Table 154-2

| Size | Pitch circle | Offset amount | Basic load rating | | | | Allowable moment load Mc* ³ | | Moment stiffness Km* ⁴ | | Allowable radial load* ⁵ | Allowable axial load* ⁵ |
|------|--------------|---------------|---|------|---|------|--|------|-----------------------------------|------------------|-------------------------------------|------------------------------------|
| | dp | R | Basic dynamic load rating C* ¹ | | Basic static load rating Co* ² | | Nm | kgfm | ×10 ⁴ Nm/rad | kgfm/ arc min | | |
| | m | m | N | kgf | N | kgf | | | | | N | N |
| 25 | 0.085 | 0.0153 | 11400 | 1163 | 20300 | 2071 | 410 | 41.8 | 37.9 | 11.3 | 1330 | 1990 |
| 32 | 0.1115 | 0.015 | 22500 | 2296 | 39900 | 4071 | 932 | 95 | 86.1 | 25.7 | 2640 | 3940 |

[Note: Table 153-1, -2 and -3 Table 154-1 and -2]

- *1 The basic dynamic load rating means a certain static radial load so that the basic dynamic rated life of the roller bearing is a million rotations.
- *2 The basic static load rating means a static load that gives a certain level of contact stress (4kN/mm²) in the center of the contact area between rolling element receiving the maximum load and orbit.
- *3 The allowable moment load is a maximum moment load applied to the bearing. Within the allowable range, basic performance is maintained and the bearing is operable. Check the bearing life based on the calculations shown on the next page.
- *4 The value of the moment stiffness is the average value.
- *5 The allowable radial load and allowable axial load are the values that satisfy the life of a speed reducer when a pure radial load or an axial load applies to the main bearing. (Lr + R = 0 mm for radial load and La = 0 mm for axial load) If a compound load applies, refer to the calculations shown on the next page.

How to calculate the maximum moment load

- HPGP
- HPG
- CSG-GH
- CSF-GH
- HPF

Maximum moment load (M_{max}) is obtained as follows. Make sure that $M_{max} \leq Mc$.

Formula 155-1

$$M_{max} = Fr_{max}(L_r + R) + Fa_{max}La$$

| | | | |
|------------|------------------|---------|--|
| Fr_{max} | Max. radial load | N (kgf) | See Fig. 155-1. |
| Fa_{max} | Max. axial load | N (kgf) | See Fig. 155-1. |
| L_r, La | — | m | See Fig. 155-1. |
| R | Offset amount | m | See Fig. 155-1. See "Output Bearing Specifications" of each series, p.153 & 154 |

Figure 155-1

External load influence diagram

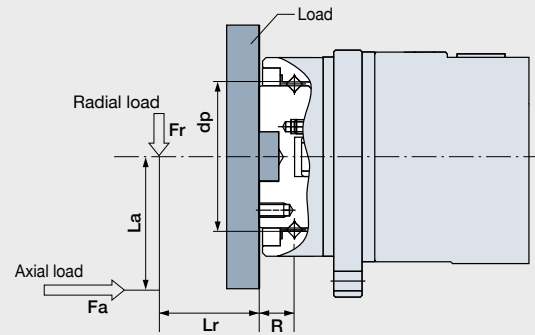

How to calculate the radial and the axial load coefficient

- HPGP
- HPG
- CSG-GH
- CSF-GH
- HPF

The radial load coefficient (X) and the axial load coefficient (Y)

Formula 155-2

| Formula | X | Y |
|--|------|------|
| $\frac{Fa_{av}}{Fr_{av} + 2(Fr_{av}(L_r + R) + Fa_{av} \cdot La) / dp} \leq 1.5$ | 1 | 0.45 |
| $\frac{Fa_{av}}{Fr_{av} + 2(Fr_{av}(L_r + R) + Fa_{av} \cdot La) / dp} > 1.5$ | 0.67 | 0.67 |

| | | | |
|-----------|--------------------------|---------|--|
| Fr_{av} | Average radial load | N (kgf) | See "How to calculate the average load below." |
| Fa_{av} | Average axial load | N (kgf) | See "How to calculate the average load below." |
| L_r, La | — | m | See Fig. 155-1. |
| R | Offset amount | m | See Fig. 155-1. See "Output Bearing Specifications" of each series, p. 153 & 154. |
| dp | Circular pitch of roller | m | See Fig. 155-1. See "Output Bearing Specifications" of each series, p. 153 & 154. |

How to calculate the average load (Average radial load, average axial load, average output speed)

- HPGP
- HPG
- CSG-GH
- CSF-GH
- HPF

If the radial load and the axial load fluctuate, they should be converted into the average load to check the life of the cross roller bearing.

How to obtain the average radial load (Fr_{av}) Formula 155-3

$$Fr_{av} = \sqrt[10/3]{\frac{n_1 t_1 (|Fr_1|)^{10/3} + n_2 t_2 (|Fr_2|)^{10/3} + \dots + n_n t_n (|Fr_n|)^{10/3}}{n_1 t_1 + n_2 t_2 + \dots + n_n t_n}}$$

Note that the maximum radial load within the t_1 section is Fr_1 and the maximum radial load within the t_3 section is Fr_3 .

How to obtain the average axial load (Fa_{av}) Formula 155-4

$$Fa_{av} = \sqrt[10/3]{\frac{n_1 t_1 (|Fa_1|)^{10/3} + n_2 t_2 (|Fa_2|)^{10/3} + \dots + n_n t_n (|Fa_n|)^{10/3}}{n_1 t_1 + n_2 t_2 + \dots + n_n t_n}}$$

Note that the maximum axial load within the t_1 section is Fa_1 and the maximum axial load within the t_3 section is Fa_3 .

How to obtain the average output speed (N_{av}) Formula 155-5

$$N_{av} = \frac{n_1 t_1 + n_2 t_2 + \dots + n_n t_n}{t_1 + t_2 + \dots + t_n}$$

Harmonic Planetary & Harmonic Drive
Technical Information / Handling Explanation

Harmonic Planetary® & Harmonic Drive® Gearheads 155

How to calculate the life HPGP HPG CSG-GH CSF-GH HPF

Calculate the life of the cross roller bearing using Formula 156-1. You can obtain the dynamic equivalent load (P_c) using Formula 156-2.

Formula 156-1

$$L_{10} = \frac{10^6}{60 \times N_{av}} \times \left(\frac{C}{f_w \cdot P_c} \right)^{10/3}$$

| | | | |
|-----------------------|---------------------------|---------|---------------------------------------|
| L₁₀ | Life | hour | — |
| N_{av} | Ave. output speed | rpm | See "How to calculate the ave. load." |
| C | Basic dynamic load rating | N (kgf) | See "Output Bearing Specs." |
| P_c | Dynamic equivalent load | N (kgf) | See Formula 156-2. |
| f_w | Load coefficient | — | See Table 156-1. |

Formula 156-2

$$P_c = X \cdot \left(Fr_{av} + \frac{2(Fr_{av}(L_r + R) + Fa_{av} \cdot La)}{dp} \right) + Y \cdot Fa_{av}$$

| | | | |
|--------------------------|-------------------------|---------|---|
| Fr_{av} | Average radial load | N (kgf) | See "How to calculate the ave. load." |
| Fa_{av} | Average axial load | N (kgf) | |
| dp | Pitch Circle of roller | m | See "Output Bearing Specs." |
| X | Radial load coefficient | — | See "How to calculate the radial load coefficient and the axial load coefficient." |
| Y | Axial load coefficient | — | |
| L_r, La | — | m | See Figure 155-1. See "External load influence diagram." |
| R | Offset amount | m | See Figure 155-1. See "External load influence diagram" and "Output Bearing Specs" of each series. |

Table 156-1

| Load status | f _w |
|---|----------------|
| During smooth operation without impact or vibration | 1 to 1.2 |
| During normal operation | 1.2 to 1.5 |
| During operation with impact or vibration | 1.5 to 3 |

How to calculate the life during oscillating motion HPGP HPG CSG-GH CSF-GH HPF

Calculate the life of the cross roller bearing during oscillating motion by Formula 156-3.

Formula 156-3

$$L_{oc} = \frac{10^6}{60 \times n_1} \times \frac{90}{\theta} \times \left(\frac{C}{f_w \cdot P_c} \right)^{10/3}$$

| | | | |
|-----------------------|---|---------|-----------------------------|
| L_{oc} | Rated life under oscillating motion | hour | — |
| n₁ | No. of reciprocating oscillation per min. | cpm | — |
| C | Basic dynamic load rating | N (kgf) | See "Output Bearing Specs." |
| P_c | Dynamic equivalent load | N (kgf) | See Formula 156-2. |
| f_w | Load coefficient | — | See Table 156-1. |
| θ | Oscillating angle /2 | Deg. | See Figure 156-1. |

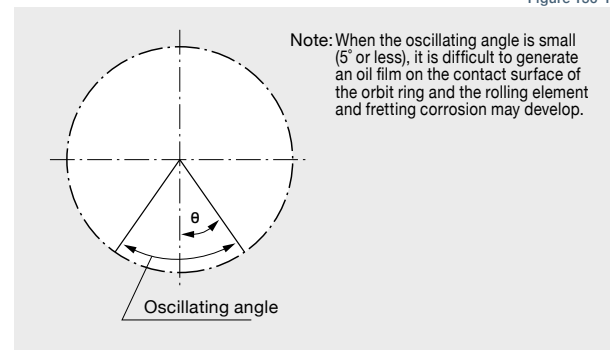

Note When it is used for a long time while the rotation speed of the output shaft is in the ultra-low operation range (0.02rpm or less), the lubrication of the bearing becomes insufficient, resulting in deterioration of the bearing or increased load in the output side. When using it in the ultra-low operation range, contact us.

How to calculate the static safety coefficient HPGP HPG CSG-GH CSF-GH HPF

In general, the basic static load rating (C_0) is considered to be the permissible limit of the static equivalent load. However, obtain the limit based on the operating and required conditions. Calculate the static safety coefficient (f_s) of the cross roller bearing using Formula 156-4.

General values under the operating condition are shown in Table 156-2. You can calculate the static equivalent load (P_0) using Formula 156-5.

Formula 156-4

$$f_s = \frac{C_0}{P_0}$$

| | | | |
|----------------------|------------------------|---------|-----------------------------|
| C₀ | Basic static load | N (kgf) | See "Output Bearing Specs." |
| P₀ | Static equivalent load | N (kgf) | See Formula 156-5. |

Formula 156-5

$$P_0 = Fr_{max} + \frac{2M_{max}}{dp} + 0.44Fa_{max}$$

| | | | |
|-------------------------|------------------|-----------|--|
| Fr_{max} | Max. radial load | N (kgf) | |
| Fa_{max} | Max. axial load | N (kgf) | See "How to calculate the max. moment load." |
| M_{max} | Max. moment load | Nm (kgfm) | |
| dp | Pitch Circle | m | See "Output Bearing Specs" of each series. |

Table 156-2

| Load status | f _s |
|--------------------------------------|----------------|
| When high precision is required | ≥ 3 |
| When impact or vibration is expected | ≥ 2 |
| Under normal operating condition | ≥ 1.5 |

Input Bearing Specifications and Checking Procedure

Check the maximum load and life of the bearing on the input side if the reducer is an HPG input shaft unit or an HPF hollow shaft unit.

Checking procedure

HPG

HPF

(1) Checking maximum load

Calculate:

Maximum moment load (Mi_{max})
Maximum axial load (Fai_{max})
Maximum radial load (Fri_{max})



Maximum moment load (Mi_{max}) \leq Allowable moment load (Mc)
Maximum axial load (Fai_{max}) \leq Allowable axial load (Fac)
Maximum radial load (Fri_{max}) \leq Allowable radial load (Frc)

(2) Checking the life

Calculate:

Average moment load (Mi_{av})
Average axial load (Fai_{av})
Average input speed (Ni_{av})



Calculate the life and check it.

Specification of input bearing

Specification of input bearing

HPG

Table 157-1

| Size | Basic load rating | | | |
|------|--------------------------------|------|--------------------------------|------|
| | Basic dynamic load rating Cr | | Basic static load rating Cor | |
| | N | kgf | N | kgf |
| 11 | 2700 | 275 | 1270 | 129 |
| 14 | 5800 | 590 | 3150 | 320 |
| 20 | 9700 | 990 | 5600 | 570 |
| 32 | 22500 | 2300 | 14800 | 1510 |
| 50 | 35500 | 3600 | 25100 | 2560 |
| 65 | 51000 | 5200 | 39500 | 4050 |

Table 157-2

| Size | Allowable moment load Mc | | Allowable axial load Fac^{*1} | | Allowable radial load Frc^{*2} | |
|------|----------------------------|-------|---------------------------------|-----|----------------------------------|-----|
| | Nm | kgfm | N | kgf | N | kgf |
| 11 | 0.16 | 0.016 | 245 | 25 | 20.6 | 2.1 |
| 14 | 6.3 | 0.64 | 657 | 67 | 500 | 51 |
| 20 | 13.5 | 1.38 | 1206 | 123 | 902 | 92 |
| 32 | 44.4 | 4.53 | 3285 | 335 | 1970 | 201 |
| 50 | 96.9 | 9.88 | 5540 | 565 | 3226 | 329 |
| 65 | 210 | 21.4 | 8600 | 878 | 5267 | 537 |

Specification of input shaft bearing

HPF

Table 157-3

| Size | Basic load rating | | | |
|------|--------------------------------|------|--------------------------------|------|
| | Basic dynamic load rating Cr | | Basic static load rating Cor | |
| | N | kgf | N | kgf |
| 25 | 14500 | 1480 | 10100 | 1030 |
| 32 | 29700 | 3030 | 20100 | 2050 |

Table 157-4

| Size | Allowable moment load Mc | | Allowable axial load Fac^{*1} | | Allowable radial load Frc^{*3} | |
|------|----------------------------|------|---------------------------------|-----|----------------------------------|------|
| | Nm | kgfm | N | kgf | N | kgf |
| 25 | 10 | 1.02 | 1538 | 157 | 522 | 53.2 |
| 32 | 19 | 1.93 | 3263 | 333 | 966 | 98.5 |

[Note: Table 157-2 and 157-4]

*1 The allowable axial load is the value of an axial load applied along the axis of rotation.

*2 The allowable radial load of HPG series is the value of a radial load applied at the mid-point of the input shaft.

*3 The allowable radial load of HPG series is the value of a radial load applied to the point of 20 mm from the shaft edge (input flange edge).

Calculating maximum moment load ON input shaft

The maximum moment load ($M_{i max}$) is calculated as follows.
Check that the following formulas are established in all circumstances:

Formula 158-1

$$M_{i max} = F_{ri max} \cdot L_{ri} + F_{ai max} \cdot L_{ai}$$

| | | | |
|------------------|------------------|---------|-----------------|
| $F_{ri max}$ | Max. radial load | N (kgf) | See Fig. 158-1. |
| $F_{ai max}$ | Max. axial load | N (kgf) | See Fig. 158-1. |
| L_{ri}, L_{ai} | ----- | m | See Fig. 158-1. |

$$M_{i max} \leq M_c \text{ (Allowable moment load)}$$

$$F_{ai max} \leq F_{ac} \text{ (Allowable axial load)}$$

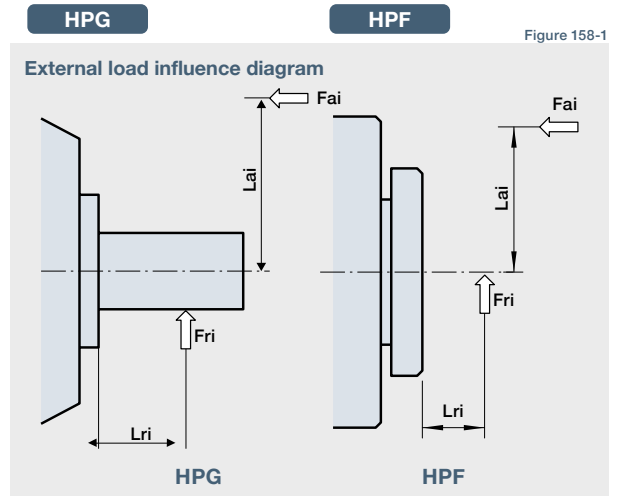

How to calculate average load (Average moment load, average axial load, average input speed)

If moment load and axial load fluctuate, they should be converted into the average load to check the life of the bearing.

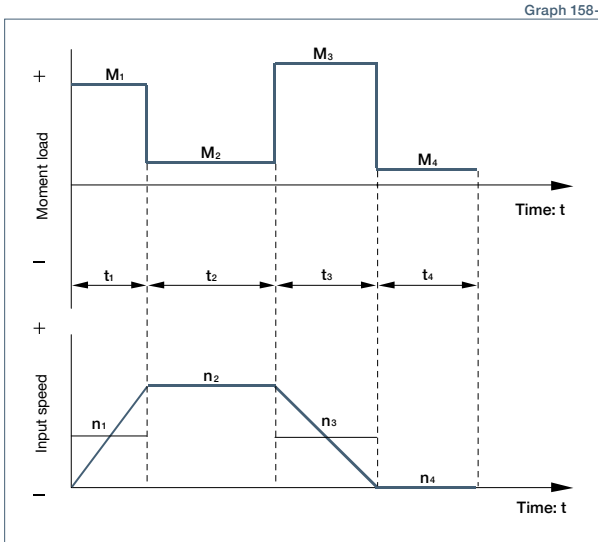

Formula 158-2

How to calculate the average moment load ($M_{i av}$)

$$M_{i av} = \sqrt[3]{\frac{n_1 t_1 (|M_{i1}|)^3 + n_2 t_2 (|M_{i2}|)^3 + \dots + n_n t_n (|M_{in}|)^3}{n_1 t_1 + n_2 t_2 + \dots + n_n t_n}}$$

Formula 158-3

How to calculate the average axial load ($F_{ai av}$)

$$F_{ai av} = \sqrt[3]{\frac{n_1 t_1 (|F_{ai1}|)^3 + n_2 t_2 (|F_{ai2}|)^3 + \dots + n_n t_n (|F_{ain}|)^3}{n_1 t_1 + n_2 t_2 + \dots + n_n t_n}}$$

Formula 158-4

How to calculate the average input speed ($N_{i av}$)

$$N_{i av} = \frac{n_1 t_1 + n_2 t_2 + \dots + n_n t_n}{t_1 + t_2 + \dots + t_n}$$

Calculating life of input bearing

Calculate the bearing life according to Calculation Formula 158-5 and check the life.

Formula 158-5

$$L_{10} = \frac{10^6}{60 \times N_{i av}} \times \left(\frac{C_r}{P_{ci}} \right)^3$$

| | | | |
|------------|---------------------------|---------|------------------------|
| L_{10} | Life | Hour | — |
| $N_{i av}$ | Average input speed | rpm | See Formula 158-4 |
| C_r | Basic dynamic load rating | N (kgf) | See Table 157-1 and -3 |
| P_{ci} | Dynamic equivalent load | N | See Table 158-1 and -2 |

Table 158-1

| Dynamic equivalent load | | HPG |
|-------------------------|--|-----|
| Size | P_{ci} | |
| 11 | $0.444 \times M_{i av} + 1.426 \times F_{ai av}$ | |
| 14 | $0.137 \times M_{i av} + 1.232 \times F_{ai av}$ | |
| 20 | $0.109 \times M_{i av} + 1.232 \times F_{ai av}$ | |
| 32 | $0.071 \times M_{i av} + 1.232 \times F_{ai av}$ | |
| 50 | $0.053 \times M_{i av} + 1.232 \times F_{ai av}$ | |
| 65 | $0.041 \times M_{i av} + 1.232 \times F_{ai av}$ | |

Table 158-2

| Dynamic equivalent load | | HPF |
|-------------------------|--|-----|
| Size | P_{ci} | |
| 25 | $121 \times M_{i av} + 2.7 \times F_{ai av}$ | |
| 32 | $106 \times M_{i av} + 2.7 \times F_{ai av}$ | |

$M_{i av}$ Average moment load Nm (kgfm) See Formula 158-2
 $F_{ai av}$ Average axial load N (kgf) See Formula 158-3

Assembly

Assemble and mount your gearhead in accordance with these instructions to achieve the best performance. Be sure to use the recommended bolts and use a torque wrench to achieve the proper tightening torques as recommended in tables below.

Motor assembly procedure HPGP HPG CSG-GH CSF-GH HPN

To properly mount the motor to the gearhead, follow the procedure outlined below, refer to figure 159-1

- (1) Turn the input shaft coupling and align the bolt head with the rubber cap hole.

- (2) With the speed reducer in an upright position as illustrated in the figure below, slowly insert the motor shaft into the coupling of speed reducer. Slide the motor shaft without letting it drop down. If the speed reducer cannot be positioned upright, slowly insert the motor shaft into the coupling of speed reducer, then tighten the motor bolts evenly until the motor flange and gearhead flange are in full contact. Exercise care to avoid tilting the motor when inserting it into the gear head.

- (3) Tighten the input shaft coupling bolt to the recommended torque specified in the table below. The bolt(s) or screw(s) is (are) already inserted into the input coupling when delivered. Check the bolt size on the confirmation drawing provided.

Bolt tightening torque

Table 159-1

| Bolt size | M3 | M4 | M5 | M6 | M8 | M10 | M12 |
|-------------------|------|------|------|------|------|------|------|
| Tightening torque | Nm | 2.0 | 4.5 | 9.0 | 15.3 | 37.2 | 73.5 |
| | kgfm | 0.20 | 0.46 | 0.92 | 1.56 | 3.8 | 7.5 |

Caution: Always tighten the bolts to the tightening torque specified in the table above. If the bolt is not tightened to the torque value recommended slippage of the motor shaft in the shaft coupling may occur. The bolt size will vary depending on the size of the gear and the shaft diameter of the mounted motor. Check the bolt size on the confirmation drawing provided.

Two setscrews need to be tightened on size 11. See the outline dimensions on page 22 (HPGP) and page 34 (HPG standard) and page 46 (HPG helical). Tighten the screws to the tightening torque specified below.

Table 159-2

| Bolt size | M3 | |
|-------------------|------|------|
| Tightening torque | Nm | 0.69 |
| | kgfm | 0.07 |

- (4) Fasten the motor to the gearhead flange with bolts.

Bolt* tightening torque

Table 159-3

| Bolt size | M2.5 | M3 | M4 | M5 | M6 | M8 | M10 | M12 |
|-------------------|------|------|------|------|------|------|------|------|
| Tightening torque | Nm | 0.59 | 1.4 | 3.2 | 6.3 | 10.7 | 26.1 | 51.5 |
| | kgfm | 0.06 | 0.14 | 0.32 | 0.64 | 1.09 | 2.66 | 5.25 |

* Recommended bolt: JIS B 1176 Hexagon socket head bolt, Strength: JIS B 1051 12.9 or higher

Caution: Be sure to tighten the bolts to the tightening torques specified in the table.

- (5) Insert the rubber cap provided. This completes the assembly. (Size 11: Fasten screws with a gasket in two places)

Figure 159-1

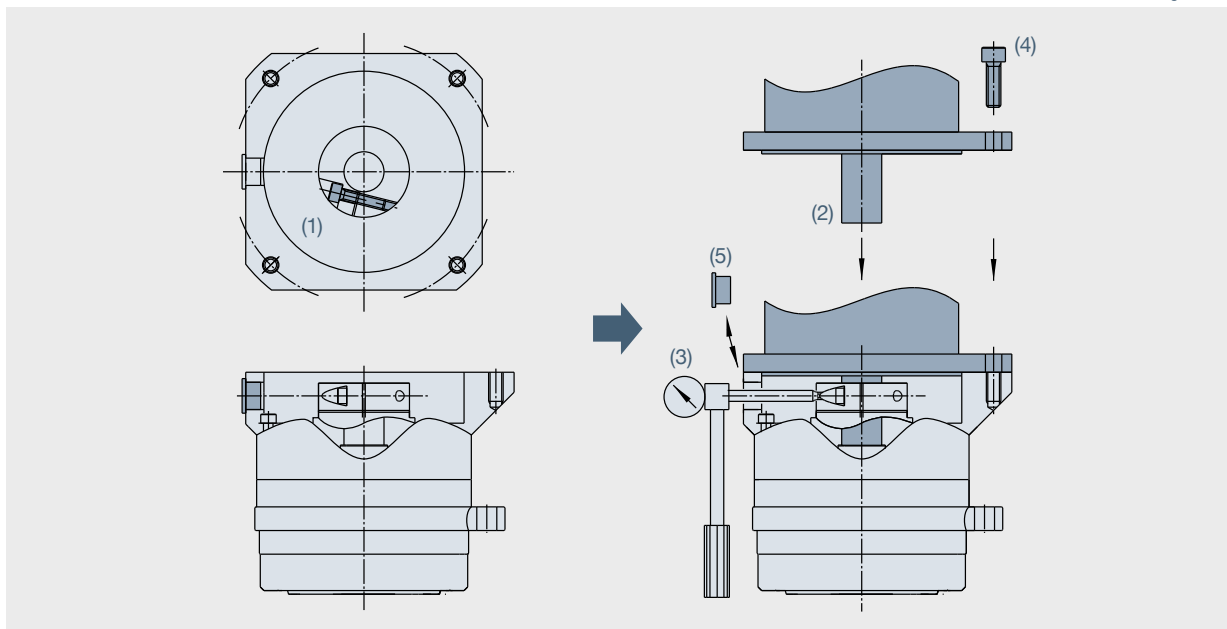

Speed reducer assembly

HPGP
HPG
CSG-GH
CSF-GH
HPF
HPN

Some right angle gearhead models weigh as much as 60 kg. No thread for an eyebolt is provided because the mounting orientation varies depending on the customer's needs. When mounting the reducer, hoist it using a sling paying extreme attention to safety.

When assembling gearheads into your equipment, check the flatness of your mounting surface and look for any burrs on tapped holes. Then fasten the flange (Part A in the diagram below) using appropriate bolts.

Bolt* tightening torque for flange (Part A in the diagram below)

Table 160-1

| Size | HPN | | | | | HPGP / HPG / CSG-GH / CSF-GH | | | | | | HPF | | |
|---------------------|------|------|------|------|------|------------------------------|------|------|------|-------|------|------|------|------|
| | 11 | 14 | 20 | 32 | 40 | 11 | 14 | 20 | 32 | 45/50 | 65 | 25 | 32 | |
| Number of bolts | 4 | 4 | 4 | 4 | 4 | 4 | 4 | 4 | 4 | 4 | 4 | 12 | 12 | |
| Bolt size | M3 | M5 | M6 | M8 | M10 | M3 | M5 | M8 | M10 | M12 | M16 | M4 | M5 | |
| Mounting PCD | mm | 50 | 70 | 100 | 130 | 165 | 46 | 70 | 105 | 135 | 190 | 260 | 127 | 157 |
| Tightening torque | Nm | 1.4 | 6.3 | 10.7 | 26.1 | 51.5 | 1.4 | 6.3 | 26.1 | 51.5 | 103 | 255 | 4.5 | 9.0 |
| | kgfm | 0.14 | 0.64 | 1.09 | 2.66 | 5.26 | 0.14 | 0.64 | 2.66 | 5.25 | 10.5 | 26.0 | 0.46 | 0.92 |
| Transmission torque | Nm | 27.9 | 110 | 223 | 528 | 1063 | 26.3 | 110 | 428 | 868 | 2030 | 5180 | 531 | 1060 |
| | kgfm | 2.85 | 11.3 | 22.8 | 53.9 | 108.5 | 2.69 | 11.3 | 43.6 | 88.6 | 207 | 528 | 54.2 | 108 |

* Recommended bolts: JIS B 1176 "Hexagon socket head bolts." Strength classification 12.9 or higher in JIS B 1051.

Mounting the load to the output flange

Follow the specifications in the table below when mounting the load onto the output flange.

Figure 160-1

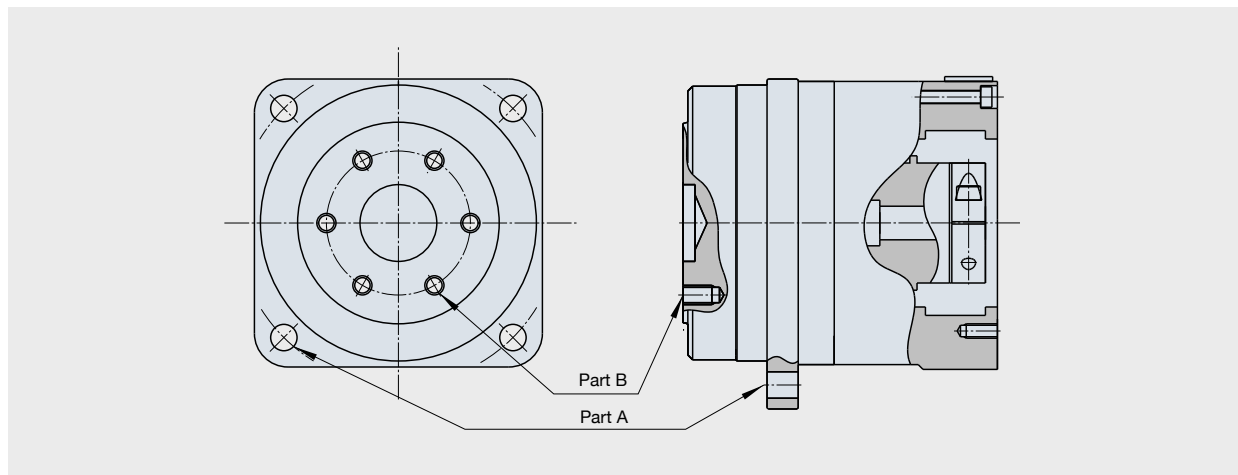

Output flange mounting specifications

Bolt* tightening torque for output flange (Part B in the Figure 160-1)

HPGP

Table 160-2

| Size | 11 | 14 | 20 | 32 | 50 | 65 | |
|---------------------|------|------|------|------|------|-------|------|
| Number of bolts | 4 | 8 | 8 | 8 | 8 | 8 | |
| Bolt size | M4 | M4 | M6 | M8 | M12 | M16 | |
| Mounting PCD | mm | 18 | 30 | 45 | 60 | 90 | 120 |
| Tightening torque | Nm | 4.5 | 4.5 | 15.3 | 37.2 | 128.4 | 319 |
| | kgfm | 0.46 | 0.46 | 1.56 | 3.8 | 13.1 | 32.5 |
| Transmission torque | Nm | 25.3 | 84 | 286 | 697 | 2407 | 5972 |
| | kgfm | 2.58 | 8.6 | 29.2 | 71.2 | 245 | 609 |

* Recommended bolts: JIS B 1176 "Hexagon socket head bolts." Strength classification 12.9 or higher in JIS B 1051.

Bolt* tightening torque for output flange (Part B in the Figure 160-1)

HPG

Table 160-3

| Size | 11 | 14 | 20 | 32 | 50 | 65 | |
|---------------------|------|------|------|------|------|-------|------|
| Number of bolts | 3 | 6 | 6 | 6 | 14 | 6 | |
| Bolt size | M4 | M4 | M6 | M8 | M8 | M16 | |
| Mounting PCD | mm | 18 | 30 | 45 | 60 | 100 | 120 |
| Tightening torque | Nm | 4.5 | 4.5 | 15.3 | 37.2 | 37.2 | 319 |
| | kgfm | 0.46 | 0.46 | 1.56 | 3.8 | 3.80 | 32.5 |
| Transmission torque | Nm | 19.0 | 63 | 215 | 524 | 2036 | 4480 |
| | kgfm | 1.9 | 6.5 | 21.9 | 53.4 | 207.8 | 457 |

* Recommended bolts: JIS B 1176 "Hexagon socket head bolts." Strength classification 12.9 or higher in JIS B 1051.

Mounting the load to the output flange

Bolt* tightening torque for output flange (Part B in Figure 160-1)

CSG-GH

Table 161-1

| Size | | 14 | 20 | 32 | 45 | 65 |
|---------------------|------|------|------|------|------|------|
| Number of bolts | | 8 | 8 | 10 | 10 | 10 |
| Bolt size | | M4 | M6 | M8 | M12 | M16 |
| Mounting PCD | mm | 30 | 45 | 60 | 94 | 120 |
| | Nm | 4.5 | 15.3 | 37 | 128 | 319 |
| Tightening torque | kgfm | 0.46 | 1.56 | 3.8 | 3.1 | 32.5 |
| | Nm | 84 | 287 | 867 | 3067 | 7477 |
| Transmission torque | kgfm | 8.6 | 29.3 | 88.5 | 313 | 763 |

Bolt* tightening torque for output flange (Part B in Figure 160-1)

CSF-GH

Table 161-2

| Size | | 14 | 20 | 32 | 45 | 65 |
|---------------------|------|------|------|------|------|------|
| Number of bolts | | 6 | 6 | 6 | 16 | 8 |
| Bolt size | | M4 | M6 | M8 | M8 | M16 |
| Mounting PCD | mm | 30 | 45 | 60 | 100 | 120 |
| | Nm | 4.5 | 15.3 | 37.2 | 37.2 | 319 |
| Tightening torque | kgfm | 0.46 | 1.56 | 3.80 | 3.80 | 32.5 |
| | Nm | 63 | 215 | 524 | 2326 | 5981 |
| Transmission torque | kgfm | 6.5 | 21.9 | 53.4 | 237 | 610 |

Bolt* tightening torque for output flange
(Part B in Figure 160-1)

HPF

Table 161-3

| Size | | 25 | 32 |
|---------------------|------|------|------|
| Number of bolts | | 12 | 12 |
| Bolt size | | M4 | M5 |
| Mounting PCD | mm | 77 | 100 |
| | Nm | 4.5 | 9.0 |
| Tightening torque | kgfm | 0.46 | 0.92 |
| | Nm | 322 | 675 |
| Transmission torque | kgfm | 32.9 | 68.9 |

* Recommended bolts: JIS B 1176 "Hexagon socket head bolts." Strength classification 12.9 or higher in JIS B 1051.

Gearheads with an output shaft

HPN

HPG

HPGP

CSG-GH

CSF-GH

HPF

Do not subject the output shaft to any impact when mounting a pulley, pinion or other parts.

An impact to the the output bearing may affect the speed reducer precision and may cause reduced life or failure.

Mechanical Tolerances

Superior mechanical precision is achieved by integrating the output flange with a high-precision cross roller bearing as a single component. The mechanical tolerances of the output shaft and mounting flange are specified below.

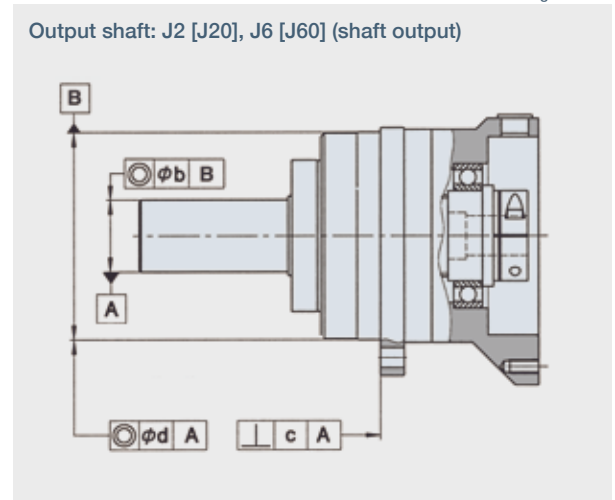
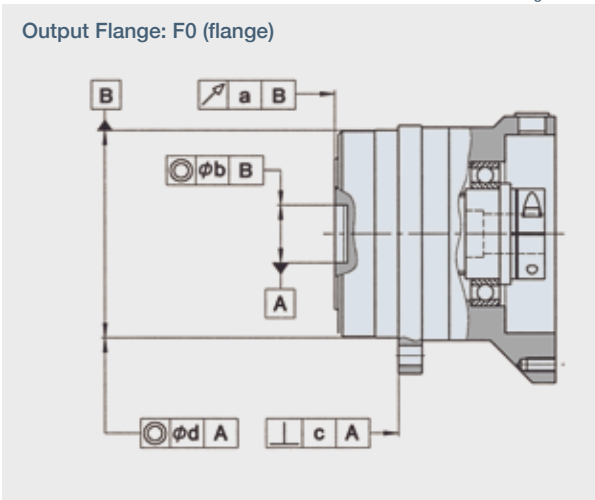

| | HPGP | HPG | CSG-GH | CSF-GH |
|---------------------------------------|--|-------|--------|--------|
| Size | Table 162-1 | | | |
| Axial runout of output flange a | Radial runout of output flange pilot or output shaft b | | | |
| Perpendicularity of mounting flange c | Concentricity of mounting flange d | | | |
| 11 | 0.020 | 0.030 | 0.050 | 0.040 |
| 14 | 0.020 | 0.040 | 0.060 | 0.050 |
| 20 | 0.020 | 0.040 | 0.060 | 0.050 |
| 32 | 0.020 | 0.040 | 0.060 | 0.050 |

| | HPGP | HPG |
|----|-------------|-------|
| 50 | Table 162-2 | |
| 65 | 0.040 | 0.080 |

| | CSG-GH | CSF-GH |
|----|-------------|--------|
| 45 | Table 162-3 | |
| 65 | 0.020 | 0.050 |

| | HPF | |
|----|-------------|-------|
| 25 | Table 162-4 | |
| 32 | 0.020 | 0.050 |

* T.I.R.: Total indicator reading (T.I.R.* Unit: mm)

Lubrication

Prevention of grease and oil leakage

(Common to all models)

- Only use the recommended greases.
- Provisions for proper sealing to prevent grease leakage are incorporated into the gearheads. However, please note that some leakage may occur depending on the application or operating condition. Discuss other sealing options with our applications engineers.
- When mounting the gearhead horizontally, position the gearhead so that the rubber cap in the adapter flange is facing upwards.

(CSG/CSF-GH Series)

- Contact us when using HarmonicDrive® CSG/CSF-GH series with the output shaft facing downward (motor on top) at a constant load or rotating continuously in one direction.

Sealing

(Common to all models)

- Provisions for proper sealing to prevent grease leakage from the input shaft are incorporated into the gearhead.
- A double lip Teflon oil seal is used for the output shaft (HPGP/HPG uses a single lip seal), gaskets or o-rings are used on all mating surfaces, and non contact shielded bearings are used for the motor shaft coupling (Double sealed bearings (D type) are available as an option*). On the CSG/CSF-GH series, non contact shielded bearing and a Teflon oil seal with a spring is used.
- Material and surface: Gearbox: Aluminum, corrosion protected roller bearing steel, carbon steel (output shaft). Adapter flange: (if provided by Harmonic Drive) high-strength aluminum or carbon steel. Screws: black phosphate. The ambient environment should not subject any corrosive agents to the above mentioned material. The product provides protection class IP 54 under the provision that corrosion from the ambient atmosphere (condensation, liquids or gases) at the running surface of the output shaft seal is prevented. If necessary, the adapter flange can be sealed by means of a surface seal (e.g. Loctite 515).

* D type: Bearing with a rubber contact seal on both sides

(HPG/HPGP/HPF/HPN Series)

- Using the double sealed bearing (D type) for the HPGP/HPG series gearhead will result in a slightly lower efficiency compared to the standard product.
- An oil seal without a spring is used ON the input side of HPG series with an input shaft (HPG-1U) and HPF series hollow shaft reducer. An option for an oil seal with a spring is available for improved seal reliability, however, the efficiency will be slightly lower (available for HPF and HPG series for sizes 14 and larger).
- Do not remove the screw plug and seal cap of the HPG series right angle gearhead. Removing them may cause leakage of grease or affect the precision of the gear.

Standard Lubricants

HPG/HPGP/HPF/HPN Series

The standard lubrication for the HPG/HPGP/HPF/HPN series gearheads is grease.
 All gearheads are lubricated at the factory prior to shipment and additional application of grease during assembly is not required.
 The gearheads are lubricated for the life of the gear and do not require re-lubrication.
 High efficiency is achieved through the unique planetary gear design and grease selection.

Lubricants

Harmonic Grease SK-2 (HPGP/HPG-14, 20, 32)
 Manufacturer: Harmonic Drive Systems Inc.

Base oil: Refined mineral oil
 Thickening agent: Lithium soap
 Additive: Extreme pressure agent and other
 Standard: NLGI No. 2
 Consistency: 265 to 295 at 25°C
 Dropping point: 198°C
 Color: Green

EPNOC Grease AP (N) 2 (HPGP/HPG-11, 50, 65/HPF-25, 32)
 Manufacturer: Nippon Oil Co.

Base oil: Refined mineral oil
 Thickening agent: Lithium soap
 Additive: Extreme pressure agent and other
 Standard: NLGI No. 2
 Consistency: 282 at 25°C
 Dropping point: 200°C
 Color: Light brown

PYRONOC UNIVERSAL 00 (HPG right angle gearhead/HPN)
 Manufacturer: Nippon Oil Co.

Base oil: Refined mineral oil
 Thickening agent: Urea
 Standard: NLGI No. 00
 Consistency: 420 at 25°C
 Dropping point: 250°C or higher
 Color: Light yellow

MULTEMP AC-P (HPG-X-R)
 Manufacturer: KYODO YUSHI CO, LTD

Base oil: Composite hydrocarbon oil and diester
 Thickening agent: Lithium soap
 Additive: Extreme pressure and others
 Standard: NLGI No. 2
 Consistency: 280 at 25°C
 Dropping point: 200°C
 Color: Black viscose

Ambient operating temperature range: -10°C to +40°C

The lubricant may deteriorate if the ambient operating temperature is outside of recommended operating range. Please contact our sales office or distributor for operation outside of the ambient operating temperature range.
 The temperature rise of the gear depends upon the operating cycle, ambient temperature and heat conduction and radiation based on the customers installation of the gear. A housing surface temperature of 70°C is the maximum allowable limit.

CSG-GH/CSF-GH Series

The standard lubrication for the CGS-GH / CSF-GH series gearheads is grease. All gearheads are lubricated at the factory prior to shipment and additional application of grease during assembly is not necessary.

Lubricants

Harmonic Grease SK-1A (Size 20, 32, 45, 65)
 Manufacturer: Harmonic Drive Systems Inc.

This grease has been developed exclusively for HarmonicDrive® gears and is excellent in durability and efficiency compared to commercial general-purpose grease.

Base oil: Refined mineral oil
 Thickening Agent: Lithium soap
 Additive: Extreme pressure agent and other
 Standard: NLGI No. 2

Consistency: 265 to 295 at 25°C
 Dropping point: 197°C
 Color: Yellow

Harmonic Grease SK-2 (Size 14)
 Manufacturer: Harmonic Drive Systems Inc.

This grease has been developed exclusively for smaller sized HarmonicDrive® gears and allows smooth wave generator rotation.

Base oil: Refined mineral oil
 Thickening Agent: Lithium soap
 Additive: Extreme pressure agent and other
 Standard: NLGI No. 2

Consistency: 265 to 295 at 25°C
 Dropping point: 198°C
 Color: Green

Ambient operating temperature range: -10°C to +40°C

The lubricant may deteriorate if the ambient operating temperature is outside the recommended temperature range. Please contact our sales office or distributor for operation outside of the ambient operating temperature range.

The temperature rise of the gear depends upon the operating cycle, ambient temperature and heat conduction and radiation based on the customers installation of the gear. A housing surface temperature of 70°C is the maximum allowable limit.

When to change the grease

The life of the Harmonic Drive® gear is affected by the grease performance. The grease performance varies with temperature and deteriorates at elevated temperatures. Therefore, the grease will need to be changed sooner than usual when operating at higher temperatures. The graph on the right indicates when to change the grease based upon the temperature (when the average load torque is less than or equal to the rated output torque at 2000 rpm). Also, using the formula below, you can calculate when to change the grease when the average load torque exceeds the rated output torque (at 2000 rpm).

Formula to calculate the grease change interval when the average load torque exceeds the rated torque Formula 164-1

$$L_{GT} = L_{GTn} \times \left(\frac{T_r}{T_{av}} \right)^3$$

Formula symbols

Table 164-1

| | | | |
|-----------|---|-----------------|--|
| L_{GT} | Grease change interval when $T_{av} > T_r$ | Input rotations | _____ |
| L_{GTn} | Grease change interval when $T_{av} \leq T_r$ | Input rotations | See Graph 164-1 |
| T_r | Output torque at 2000 rpm | Nm, kgfm | See the "Rating table" on pages 87 & 97. |
| T_{av} | Average load torque | Nm, kgfm | Calculation formula: See page 111. |

When to change the grease:
LGTn (when the average load torque is equal to or less than the rated output torque at 2000 rpm)

Figure 164-1

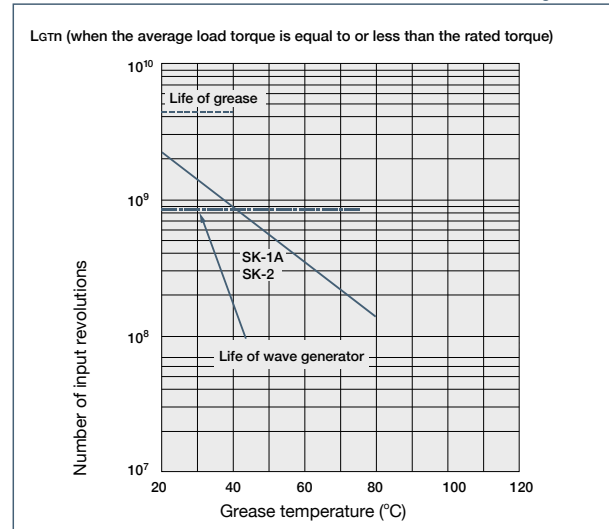

* L10 Life of wave generator bearing

Reference values for grease refill amount

Table 164-2

| | | | | | |
|-----------|-----|-----|-----|------|------|
| Size | 14 | 20 | 32 | 45 | 65 |
| Amount: g | 0.8 | 3.2 | 6.6 | 11.6 | 78.6 |

Precautions when changing the grease

Strictly observe the following instructions when changing the grease to avoid problems such as grease leakage or increase in running torque.

- Note that the amount of grease listed in Table 164-2 is the amount used to lubricate the gear at assembly. This should be used as a reference. Do not exceed this amount when re-greasing the gearhead.
- Remove grease from the gearhead and refill it with the same quantity. The adverse effects listed above normally do not occur until the gear has been re-greased 2 times. When re-greasing 3 times or more, it is essential to remove grease (using air pressure or other means) before re-lubricating with the same amount of grease that was removed.

Warranty

Please contact us or visit our website at www.harmonicdrive.net for warranty details for your specific product.

All efforts have been made to ensure that the information in this catalog is complete and accurate. However, Harmonic Drive LLC is not liable for any errors, omissions or inaccuracies in the reported data. Harmonic Drive LLC reserves the right to change the product specifications, for any reason, without prior notice. For complete details please refer to our current Terms and Conditions posted on our website.

Disposal

When disposing of the product, disassemble it and sort the component parts by material type and dispose of the parts as industrial waste in accordance with the applicable laws and regulations. The component part materials can be classified into three categories.

- (1) Rubber parts: Oil seals, seal packings, rubber caps, seals of shielded bearings on input side (D type only)
- (2) Aluminum parts: Housings, motor flanges
- (3) Steel parts: Other parts

Trademark

HarmonicDrive® is a registered trademark of Harmonic Drive LLC.

HarmonicPlanetary® is a registered trademark of Harmonic Drive LLC.

Safety

 **Warning** : Means that improper use or handling could result in a risk of death or serious injury.

 **Caution** : Means that improper use or handling could result in personal injury or damage to property.





Application Restrictions









This product cannot be used for the following applications:





- * Space flight hardware
- * Aircraft equipment
- * Nuclear power equipment
- * Equipment and apparatus used in residential dwellings
- * Vacuum environments
- * Automotive equipment
- * Personal recreation equipment
- * Equipment that directly works on human bodies
- * Equipment for transport of humans
- * Equipment for use in a special environment
- * Medical equipment

Please consult Harmonic Drive LLC beforehand if intending to use one of our product for the aforementioned applications.

Fail-safe devices that prevent an accident must be designed into the equipment when the products are used in any equipment that could result in personal injury or damage to property in the event of product failure.

| Design Precaution: Be certain to read the catalog when designing the equipment. | |
|--|---|
|  Caution | <p>Use only in the proper environment.</p> <ul style="list-style-type: none"> ● Please ensure to comply with the following environmental conditions: <ul style="list-style-type: none"> • Ambient temperature 0 to 40°C • No splashing of water or oil • Do not expose to corrosive or explosive gas • No dust such as metal powder |
|  Caution | <p>Install the equipment properly.</p> <ul style="list-style-type: none"> ● Carry out the assembly and installation precisely as specified in the catalog. ● Observe our recommended fastening methods (including bolts used and tightening torques). ● Operating the equipment without precise assembly can cause problems such as vibration, reduction in life, deterioration of precision and product failure. |
|  Caution | <p>Install the equipment with the required precision.</p> <ul style="list-style-type: none"> ● Design and assemble parts to keep all catalog recommended tolerances for installation. ● Failure to hold the recommended tolerances can cause problems such as vibration, reduction in life, deterioration of precision and product failure. |
|  Caution | <p>Use the specified lubricant.</p> <ul style="list-style-type: none"> ● Using other than our recommended lubricant can reduce the life of the product. Replace the lubricant as recommended. ● Gearheads are factory lubricated. Do not mix installed lubricant with other kinds of grease. |

| Operational Precaution: Be certain to read the catalog before operating the equipment. | |
|--|--|
|  Caution | <p>Use caution when handling the product and parts.</p> <ul style="list-style-type: none"> ● Do not hit the gear or any part with a hammer. ● If you use the equipment in a damaged condition, the gearhead may not perform to catalog specifications. It can also cause problems including product failure. |
|  Caution | <p>Operate within the allowable torque range.</p> <ul style="list-style-type: none"> ● Do not apply torque exceeding the momentary peak torque. Applying excess torque can cause problems such as loosened bolts, generation of backlash and product failure. ● An arm attached directly to the output shaft that strikes a solid object can damage the arm or cause the output of the gearhead to fail. |
|  Caution | <p>Do not alter or disassemble the product or parts.</p> <ul style="list-style-type: none"> ● Harmonic Planetary® and Harmonic Drive® products are manufactured as matched sets. Catalog ratings may not be achieved if the component parts are interchanged. |
|  Caution | <p>Do not disassemble the products.</p> <ul style="list-style-type: none"> ● Do not disassemble and reassemble the products. Original performance may not be achieved. |
|  Warning | <p>Do not use your finger to turn the gear.</p> <ul style="list-style-type: none"> ● Do not insert your finger into the gear under any circumstances. The finger may get caught in the gear causing an injury. |
|  Caution | <p>Stop operating the system if any abnormality occurs.</p> <ul style="list-style-type: none"> ● Shut down the system promptly if any abnormal sound or vibration is detected, the rotation has stopped, an abnormally high temperature is generated, an abnormal motor current value is observed or any other anomalies are detected. Continuing to operate the system may adversely affect the product or equipment. ● Please contact our sales office or distributor if any anomaly is detected. |
|  Warning | <p>Large sizes (45, 50 and 65) are heavy. Use caution when handling.</p> <ul style="list-style-type: none"> ● They are heavy and may cause a lower-back injury or an injury if dropped on a hand or foot. Wear protective shoes and back support when handling the product. |
|  Caution | <ul style="list-style-type: none"> ● Rust-proofing was applied before shipping. However, please note that rusting may occur depending on the customers' storage environment. ● Although black oxide finish is applied to some of our products, it does not guarantee that rust will not form. |

| Handling Lubricant | |
|--|---|
|  Warning | <p>Precautions on handling lubricants</p> <ul style="list-style-type: none"> ● Lubricant in the eye can cause inflammation. Wear protective glasses to prevent it from getting in your eye. ● Lubricant coming in contact with the skin can cause inflammation. Wear protective gloves when you handle the lubricant to prevent it from contacting your skin. ● Do not ingest (to avoid diarrhea and vomiting). ● Use caution when opening the container. There may be sharp edges that can cut your hand. Wear protective gloves. ● Keep lubricant out of reach of children. |
|  Caution | <p>Disposal of waste oil and containers</p> <ul style="list-style-type: none"> ● Follow all applicable laws regarding waste disposal. Contact your distributor if you are unsure how to properly dispose of the material. ● Do not apply pressure to an empty container. The container may explode. ● Do not weld, heat, drill or cut the container. This may cause residual oil to ignite or cause an explosion. |
|  Warning | <p>First-aid</p> <ul style="list-style-type: none"> ● Inhalation: Remove exposed person to fresh air if adverse effects are observed. ● Ingestion: Seek immediate medical attention and do not induce vomiting unless directed by medical personnel. ● Eyes: Flush immediately with water for at least 15 minutes. Get immediate medical attention. ● Skin: Wash with soap and water. Get medical attention if irritation develops. |
|  Caution | <p>Storage</p> <ul style="list-style-type: none"> ● Tightly seal the container after use. Store in a cool, dry, dark place. Keep away from open flames and high temperatures. |
|  Caution | <p>Disposal</p> <p>Please dispose of as industrial waste.</p> <ul style="list-style-type: none"> ● Please dispose of the products as industrial waste when their useful life is over. |

Major Applications of Our Products



Metal Working Machines



Processing Machine Tools



Measurement, Analytical and Test Systems



Medical Equipment



Telescopes

Source: National observatory of Inter-University Research Institute Corporation

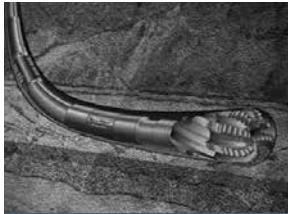

Energy

Courtesy of Halliburton/Sperry Drilling Services

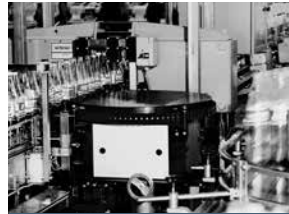

Crating and Packaging Machines



Communication Equipment



Space Flight Hardware

Rover image created by Dan Maas, copyrighted to Cornell and provided courtesy NASA/JPL-Caltech.

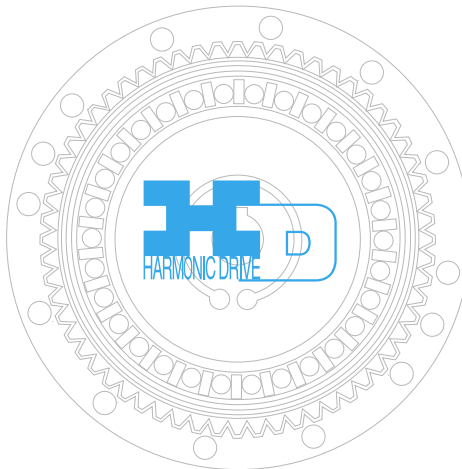

Glass and Ceramic Manufacturing Systems



Robots



Humanoid Robots

Source: Honda Motor Co., Ltd.



Printing, Bookbinding and Paper Machines



Semiconductor Manufacturing Equip.



Optical Equipment



Machine Tools



Paper-making Machines



Flat Panel Display Manufacturing Equip.

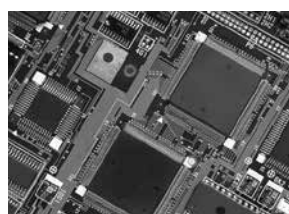

Printed Circuit Board Manufacturing Machines



Aerospace

Experts in Precision Motion Control

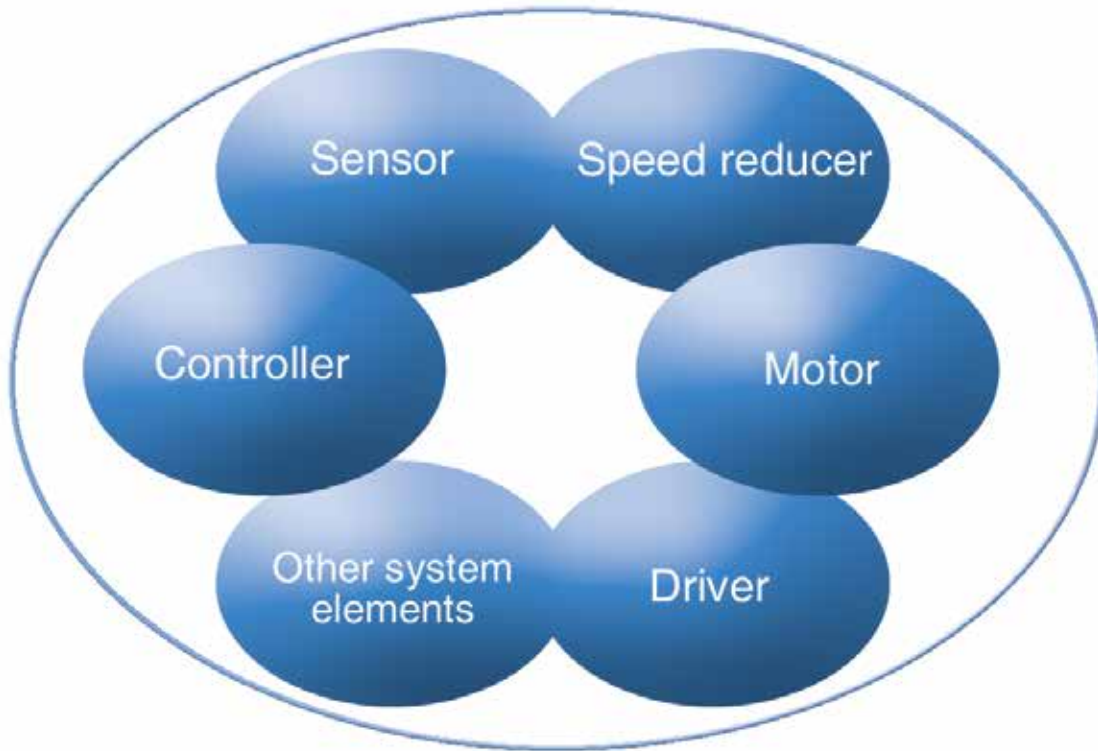

Other Products

HarmonicDrive® Gearing

HarmonicDrive® speed reducer delivers precise motion control by utilizing the strain wave gearing principle.

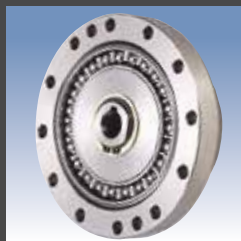

Rotary Actuators

High-torque actuators combine performance matched servomotors with HarmonicDrive® gears to deliver excellent dynamic control characteristics.

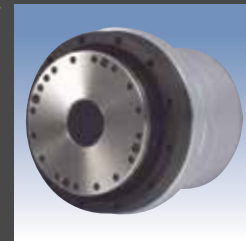

Linear Actuators

Compact linear actuators combine a precision lead screw and HarmonicDrive® gear. Our versatile actuators deliver both ultra precise positioning and high torque.



CSF Mini Gearheads

CSF mini gearheads provide high positioning accuracy in a super-compact package.



Harmonic Drive LLC

Boston US Headquarters

247 Lynnfield Street
Peabody, MA 01960

New York Sales Office

100 Motor Parkway
Suite 116
Hauppauge, NY 11788

California Sales Office

333 W. San Carlos Street
Suite 1070
San Jose, CA 95110

Chicago Sales Office

137 N. Oak Park Ave., Suite 410
Oak Park, IL 60301

T: 800.921.3332

T: 978.532.1800

F: 978.532.9406

www.HarmonicDrive.net

Group Companies

Harmonic Drive Systems, Inc.
6-25-3 Minami-Ohi, Shinagawa-ku
Tokyo 141-0013, Japan

Harmonic Drive AG
Hoenbergstrasse, 14, D-6555
Limburg/Lahn Germany

Harmonic Drive®, Harmonic Gearhead®, Harmonic Planetary® and Quick Connect® are registered trademarks of Harmonic Drive LLC. All other trademarks are property of their respective owners.

